

SIRIUS RELAYS

Contents	Pages
Section Overview	11/2-11/3
Temperature Monitoring Relays	
Overview	11/4
Selection, 3RS10-11, 3RS20-21	
Analog with One Threshold Value	11/5
Analog with Two Threshold Values	11/5
Digital with Two Threshold Values	11/6
Technical Data	11/7
Configuration	11/8
Functions	11/9
Circuit Diagrams	11/10
Dimensions	11/11
Thermistor Motor Protection	
Overview	11/12
Selection, 3RN10	11/13
Technical Data	11/14-11/15
Functions	11/15
Configuration	11/16
Circuit Diagrams	11/17-11/18
Dimensions	11/19
Solid-State Time Relays	
Overview	11/20
Selection	
Standard Time Relay, 3RP20	11/21
Narrow Width Time Relays, 3RP15	11/21
Technical Data	11/22-11/23
Functions	11/24-11/26
Selection	
Timing Relay 7PV	11/27
Circuit Diagrams	11/28-11/29
Monitoring Relays	
For Line, Voltage and Insulation Monitoring	
Overview	11/30
Selection	11/31
Technical Data	11/32-11/35
For Current, Power Factor Monitoring	
Overview	11/36
Selection	11/37
Technical Data	11/38-11/41
For Residual Current Monitoring	
Overview	11/42
Selection	11/42
Technical Data	11/43-1/44
For Insulation Monitoring of Ungrounded AC Networks	
Overview	11/45-11/47
Technical Data	11/47-11/48
Selection	11/49
For Insulation Monitoring of Ungrounded DC and AC Networks	
Overview	11/50
Technical Data	11/50-11/53
Selection	11/54

Control Circuit Components

Function Relays, Interfaces and Converters

Contents	Pages
Monitoring Relays for Non-Electrical Quantities	
For Level Monitoring of Conductive Liquids	
Selection, 3UG4501	11/55
Accessories	11/56
Technical Data	11/57-11/59
For Underspeed Monitoring	
Selection, 3UG4651	11/60
Technical Data	11/61-11/62
Coupling Relays and Interfaces	
Coupling Relay Overview	11/63
Selection, 3TX70	11/64
Interface Relay Overview	11/65
Selection, 3TX70	11/66
Technical Data	11/67-11/70
Circuit Diagrams	11/71-11/73
Dimensions	11/74
Wide Input Interface Relay	
Overview	11/75
Selection, 3RS18	11/75
Dimensions	11/75
Interface Converters	
Overview	11/76
Selection, 3RS17	11/77
Technical Data	11/78
Configurations	11/79
Circuit Diagrams	11/80
Dimension Drawings	11/80
Power Relays	
Overview	11/81
Selection, 3TG10	11/81
Technical Data	11/82-11/83
Accessories	11/84
Circuit Diagrams	11/84
Dimensions	11/84
Plug-in Relays	
Selection, 3TX71	11/85-11/89
Technical Data	11/90-11/92
Overview	11/93
Circuit Diagrams	11/94-11/96
Dimensions	11/97-11/105

3RS10/3RS11 temperature monitoring relays

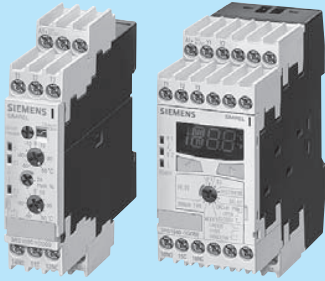

3RS10/3RS20 temperature monitoring relay for RTD or Thermocouple

Page

Selection and ordering data

- Overview 11/4
- Screw and Spring-type connection 11/5

Technical data	11/7
Configuration	11/8
Functions	11/9
Circuit diagrams	11/10
Dimension drawings	11/11

3RN1 thermistor motor protection



3RN10 thermistor motor protection for PTC temperature detectors

Page

Selection and ordering data

- Overview 11/12
- Screw and Spring-type connection 11/13
- Accessories 11/14

Technical data	11/14
Function diagrams	11/15
Functions	11/16
Circuit diagrams	11/17
Dimension drawings	11/19

Solid-State Time Relays

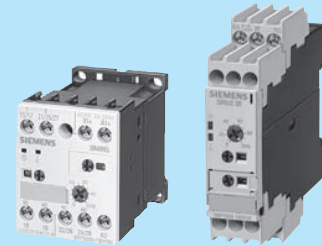

3RP20/3RP15 solid-state time relays

Page

Selection and ordering data

- Overview 11/20
- Screw and Spring-type connection 11/21

Technical data	11/22
Function diagrams	11/24
Circuit diagrams	11/28

Solid-State Time Relays



7PV solid-state relay

Page

Selection and ordering data

- Screw connection 11/27
- Accessories 11/27

Technical data	11/27
Dimension drawings	11/27



3RT19 time delay blocks for mounting on contactors

Selection and ordering data

- See Section 2

3UG3/4 monitoring relays



For electrical quantities

Selection and ordering data

- Selection Data 11/31

Overview	11/30
Technical data	11/32
Dimension drawings	11/33

Page



For non-electrical quantities

Selection and ordering data

- Selection Data 11/55

Overview	11/55
Technical data	11/57
Dimension drawings	11/58

Page

Coupling relays and interfaces

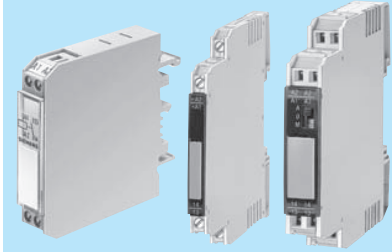

3TX70 relay and semiconductor interfaces

Selection and ordering data

- Selection Data 11/64

Overview	11/63
Technical data	11/67
Terminal diagrams	11/71
Position of terminals	11/73
Dimension drawings	11/74

Page

Coupling relays and interfaces



3RS17 interface converter

Selection and ordering data

- Screw and Spring-type connection 11/77

Overview	11/76
Technical data	11/78
Configuration	11/79
Circuit diagrams	11/80
Dimension drawings	11/80

Page



3TG10 power relay, 20A max. resistance load pole

Selection and ordering data

- AC and DC operation, hum-free With screw connection or tab connector 11/81
- Accessories 11/84

Application	11/81
Technical data	11/82
Circuit diagrams	11/84
Position of terminals	11/84
Dimension drawings	11/84

Page



3TX71 general purpose plug-in relays

Selection and ordering data

- AC and DC operation 11/85

Technical data	11/91
Contact arrangements	11/93
Circuit diagrams	11/94
Dimension drawings	11/97

Page

Overview

The 3RS1/3RS2 SIMIREL temperature monitoring relays can be used for measuring temperatures in solid, liquid and gaseous media. The temperature is acquired by the sensor in the medium, evaluated by the device and monitored for overshoot, undershoot or within a range (window function). The family consists of analog adjustable devices with one or two threshold values and digital devices that represent an excellent alternative to thermostats in the low-end performance range. The output relay picks up and releases at the threshold values in accordance with the parameter settings.

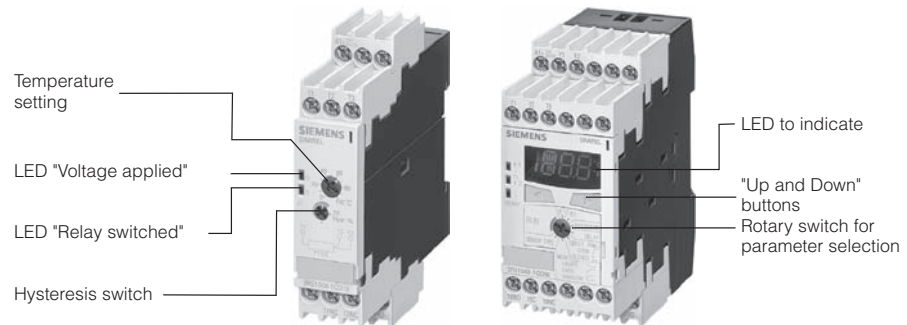

Analog evaluation units

- Sensor types: PT100/Type J/ Type K
- Measuring principle for 2- and 3-wire sensors
- Electrical isolation between sensor and supply voltage (with the exception of AC/DC 24 V devices)
- Separate designs for overshoot and undershoot
- Measuring range depending on the version for -50°C to +50°C, 0°C to 100°C, 0°C to 200°C, 0°C to 600°C or 500°C to 1000°C
- Potentiometer for adjustable limit temperature and hysteresis of 2 to 20%
- Closed-circuit principle
- Narrow 22.5 mm enclosure with 12 terminals

With one threshold value

- Supply voltage for AC/DC 24 V or AC 110/230 V
- Indication of supply voltage and relay status via LEDs
- One NO and one NC contact

With two threshold values

- Additional potentiometer for $\vartheta 2$ (hysteresis for second limit value is 5% of the measuring range)
- Supply voltage for AC/DC 24 V or 24 to 240 V
- LED indication of supply voltage and both relay states
- Open-circuit/closed-circuit principle switchover
- One NO and one CO contact

Digital evaluation units

- High-end evaluation unit for 1 or 1-3 sensor circuits
- Multifunctional digital display and three LEDs (for threshold values and Ready)
- Adjustable sensor types
- Adjustable overshoot, undershoot or window function
- Switchable open-circuit or closed-circuit principle
- Hysteresis for both threshold values (1 to 99 K)
- Memory function can be selected by means of an external control signal (Y1/Y2)
- One NO and two SPDT contacts
- Adjustable time delay from 0 to 999 s
- Wire-break and short-circuit detection with separate signaling contact (1 NO)
- Non-volatile storage of the set parameters
- 45 mm housing with 24 supply terminals
- Measuring principle for 2- and 3-wire sensors
- Electrical isolation (with the exception of AC/DC 24 V devices)
- In the 3-sensor design, the status of the individual sensors is indicated on limit value overshoot/undershoot

It clearly displays which of the connected sensors has overshoot or undershot one or both threshold values.

Advantages

- All devices are with Cage Clamp terminals
- All devices with the exception of AC/DC 24 V devices are electrically isolated
- Variants for the evaluation of 1 to 3 sensors in one unit, e.g. for multiple monitoring in a plant or for motor protection
- Easy operation without complex menu systems
- Graduated product range; the right device for every application
- High-end evaluation units with digital display – can be used for a wide temperature range and for different sensor types
- Adjustable hysteresis
- Rapid fault diagnosis due to short-circuit monitoring and sensor wire-break detection
- Power packs with wide range of input voltage reduce the number of variants
- Easy configuration for either two-point or three-point closed-loop control

Application

The 3RS1/3RS2 SIMIREL temperature monitoring relays can be used in almost any application in which limit temperatures must not be overshoot or undershot, e.g.:

Monitoring of set limit temperatures and output of alarm messages for:

- Motor and plant protection
- Switchgear cabinet temperature monitoring
- Frost monitoring
- Temperature limits for process variables, e.g. in the packaging industry or galvanising equipment
- Control of plants and machines such as heating, air-conditioning and ventilation systems, solar collectors, heat pumps or warm water supplies
- Monitoring of servo motors with KTY sensors
- Bearing and gearbox oil-level monitoring
- Monitoring of cooling liquids

Characteristics for thermocouples and resistance sensors

Thermocouples

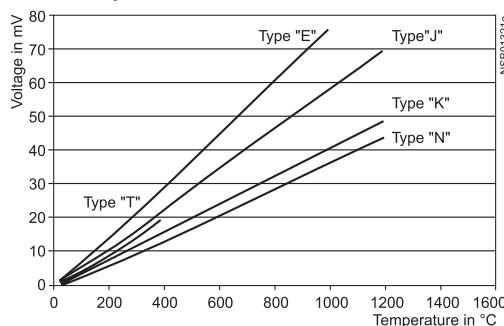

Resistance sensors

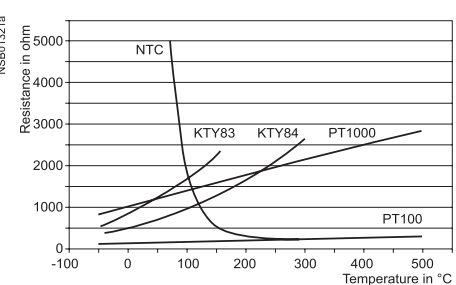

3RS10/3RS11 Temperature monitoring relays						
Sensor	Function	Measuring range	Rated control supply voltage V _S 50–60 Hz AC	Order No.	List Price \$	
Analog setting, 1 threshold value, 22.5 mm wide; analog closed-circuit principle, no holding on supply failure function; 1 NO + 1 NC						
PT100 (resistance sensor)	Overrange	–50...+50 °C	24 V AC/DC	3RS10 00-□CD00		
			110/230 V AC	3RS10 00-□CK00		
		0...+100 °C	24 V AC/DC	3RS10 00-□CD10		
			110/230 V AC	3RS10 00-□CK10		
	Underrange	0...+200 °C	24 V AC/DC	3RS10 00-□CD20		
			110/230 V AC	3RS10 00-□CK20		
		–50...+50 °C	24 V AC/DC	3RS10 10-1CD00		
			110/230 V AC	3RS10 10-1CK00		
	0...+100 °C	24 V AC/DC	3RS10 10-1CD10			
		110/230 V AC	3RS10 10-1CK10			
	0...+200 °C	24 V AC/DC	3RS10 10-1CD20			
		110/230 V AC	3RS10 10-1CK20			
Typ J (thermocouple)	Overrange	0...+200 °C	24 V AC/DC	3RS11 00-□CD20		
			110/230 V AC	3RS11 00-1CK20		
		0...+600 °C	24 V AC/DC	3RS11 00-1CD30		
			110/230 V AC	3RS11 00-1CK30		
Typ K (thermocouple)	Overrange	0...+200 °C	24 V AC/DC	3RS11 01-□CD20		
			110/230 V AC	3RS11 01-1CK20		
		0...+600 °C	24 V AC/DC	3RS11 01-1CD30		
			110/230 V AC	3RS11 01-1CK30		
		+500...+1000 °C	24 V AC/DC	3RS11 01-1CD40		
		110/230 V AC	3RS11 01-1CK40			
Analog setting for alarm and trip (2 threshold values), 22.5 mm wide; open-circuit – closed-circuit current principle can be toggled between; no holding on supply failure function; 1 NO + 1 CO						
PT100 (resistance sensor)	Overrange	–50...+50 °C	24 V AC/DC	3RS10 20-1DD00		
			24–240 V AC/DC	3RS10 20-1DW00		
		0...+100 °C	24 V AC/DC	3RS10 20-1DD10		
			24–240 V AC/DC	3RS10 20-1DW10		
		0...+200 °C	24 V AC/DC	3RS10 20-1DD20		
	Underrange		24–240 V AC/DC	3RS10 20-□DW20		
		–50...+50 °C	24 V AC/DC	3RS10 30-1DD00		
			24–240 V AC/DC	3RS10 30-1DW00		
		0...+100 °C	24 V AC/DC	3RS10 30-1DD10		
			24–240 V AC/DC	3RS10 30-1DW10		
	0...+200 °C	24 V AC/DC	3RS10 30-□DD20			
		24–240 V AC/DC	3RS10 30-1DW20			
	Typ J (thermocouple)	Overrange	0...+200 °C	24 V AC/DC	3RS11 20-□DD20	
				24–240 V AC/DC	3RS11 20-1DW20	
		0...+600 °C	24 V AC/DC	3RS11 20-1DD30		
			24–240 V AC/DC	3RS11 20-1DW30		
Typ K (thermocouple)	Overrange	0...+200 °C	24–240 V AC/DC	3RS11 21-1DW20		
		0...+600 °C	24–240 V AC/DC	3RS11 21-1DW30		
		+500...+1000 °C	24 V AC/DC	3RS11 21-1DD40		
			24–240 V AC/DC	3RS11 21-1DW40		

Analog setting evaluation devices with one and two threshold values. For analog setting devices, the threshold values and the hysteresis from 2 to 20% are set using a rotary potentiometer. For devices with 2 threshold values, the selectable hysteresis only acts on threshold value 1. For the second threshold value, the hysteresis is permanently set to 5%. This series of products was developed for applications where a setting accuracy of ± 5% is sufficient.

Screw Terminal 1
Spring-type Terminal 2

Function Relays, Interfaces and Converters

Temperature Monitoring Relays

SIRIUS
RELAYS

3RS10/3RS11

Sensor	Measuring range (measuring range limit depends on the sensor)	Rated control supply voltage V_S 50–60 Hz AC	Order No.	List Price \$
"Temperature monitor" acc. to DIN 3440, digital settings, 2 threshold values, 45 mm wide; 1 CO + 1 CO + 1 NO, memory function can be enabled using an external jumper. Relay parameters have a holding on supply failure function				
PT100/1000; KTY83/84; NTC (resistance sensor) ¹⁾	–50...+500 °C	24 V AC/DC 24–240 V AC/DC	3RS10 40-□GD50 3RS10 40-□GW50	
	–50...+932 °F	24 V AC/DC 24–240 V AC/DC	3RS20 40-□GD50 3RS20 40-□GW50	
TYPE J, K, T, E, N (thermocouple)	–99...+999 °C	24 V AC/DC 24–240 V AC/DC	3RS11 40-□GD60 3RS11 40-□GW60	
	–99...+1830 °F	24 V AC/DC 24–240 V AC/DC	3RS21 40-□GD60 3RS21 40-□GW60	
"Temperature limiter" and "temperature monitor" acc. to DIN 3440, digital settings, 2 threshold values, 45 mm wide; 1 CO + 1 CO + 1 NO, tripped state and relay parameters are saved using a holding on supply failure function				
PT100/1000; KTY83/84; NTC (resistance sensor) ¹⁾	–50...+750 °C	24 V AC/DC 24–240 V AC/DC	3RS10 42-□GD70 3RS10 42-□GW70	
	–99...+1800 °C	24 V AC/DC 24–240 V AC/DC	3RS11 42-□GD80 3RS11 42-□GW80	

Motor monitoring relays, digital settings for up to 3 sensors, 45 mm wide; 1 CO + 1 CO + 1 NO

Sensor	No of sensors	Measuring range	Rated control supply voltage V_S	Order No.	List Price \$
PT100/1000; KTY83/84; NTC (resistance sensor) ¹⁾	1 to 3 sensors	–50...+500 °C	24–240 V AC/DC	3RS10 41-□GW50	
		–50...+932 °F	24–240 V AC/DC	3RS20 41-□GW50	

¹⁾ NTC type: B57227-K333-A1 (100 °C: 1.8 k Ω ; 25 °C: 32.762 k Ω)

Screw Terminal **1**
Spring-type Terminal **2**

The short-circuit and wire breakage detection, as well as the measuring range are restricted, depending on the sensor type:

Measuring ranges in °C for thermocouple

Sensor type	Short-circuit	Wire breakage	3RS11 40 measuring range	3RS11 42 measuring range
J	–	x	–99...999	–99...1200
K	–	x	–99...999	–99...1350
T	–	x	–99...400	–99...400
E	–	x	–99...999	–99...999
N	–	x	–99...999	–99...999
S	–	x	–	0...1750
R	–	x	–	0...1750
B	–	x	–	400...1800

Measuring ranges in °C for resistance sensors

Sensor type	Short-circuit	Wire breakage	3RS10 40 measuring range	3RS10 42 measuring range
PT100	x	x	–50...500	–50...750
PT1000	x	x	–50...500	–50...500
KTY83-110	x	x	–50...175	–50...175
KTY84	x	x	–40...300	–40...300
NTC ¹⁾	x	–	80...160	80...160

¹⁾ NTC type: B57227-K333-A1 (100 °C: 1.8 k Ω ; 25 °C: 32.762 k Ω)

Evaluation units with digital settings

Temperature monitoring relays distinguish themselves due to the fact that they are extremely easy-to-use.

The actual temperature is always displayed on the three-digit LED display. A dedicated relay with one NO contact is integrated to monitor the sensor.

The relay is switched-out in the parameterizing mode.

The following parameters can be set:

- Sensor type
- 2 threshold values J_1, J_2
- 1 hysteresis; this acts on both thresholds (0–99 K)
- 1 delay time; this acts on both thresholds (0–9999 s)
- Either the open-circuit/closed-circuit principle can be selected
- Function: Overtemperature/Undertemperature (overrange/underrange) or window monitoring within a defined range

Versions with a wide-range voltage have electrical isolation.

The temperature ranges are dependant on the sensor type (refer to the function).

Technical data											
General data											
Type		3RS10 00 3RS10 10	3RS11 00	3RS11 01	3RS10 20 3RS10 30	3RS11 20 3RS11 30	3RS11 21 3RS11 31	3RS.0 40 3RS.0 41	3RS.1 40		
Sensor type		PT100	TC Type J	TC Type K	PT100	TC Type J	TC Type K	PT100; 1000 KTY83/84; NTC	TC Type J, K, T, E, N		
Width	mm	22.5							45		
Operating range	V	0.85 to 1.1 x U_s									
Rated power	W/VA	< 2 / 4							< 4 / 7		
Auxiliary circuit											
Contacts		1 NO + 1 NC			1 SPDT + 1 NO		1 SPDT + 1 SPDT + 1 NO				
Rated operational current I_e											
AC15 at AC 230 V, 50 Hz	A	3									
DC13 at 24 V	A	1									
DC13 at 240 V	A	0.1									
Required DIAZED fuse											
Utilisation category	gL/gG	A	4								
Electrical endurance	AC 15 at 3 A	100,000									
Mechanical endurance											
Mechanical operating cycles		30 x 10 ⁶									
Tripping unit											
Measuring accuracy at 20°C ambient temperature (T20)		typically < ± 5% of upper limit of scale					< ± 2K	< ± 5K	< ± 1 digit	< ± 1 digit	
Reference point accuracy		-	< ± 5 K	-	< ± 5 K	-	< ± 5 K	-	< ± 5 K		
Deviations due to ambient temperature in % of measuring range	%	<2	<3	<2	<3	0.05 °C per K deviation from T20					
Measuring cycle	ms	500									
Hysteresis adjustments											
for temperature 1		2 to 20 % of upper limit of scale							1 to 99 Kelvin, for both values		
for temperature 2		5 % of upper limit of scale									
Sensor circuit											
Typical sensor current											
PT100	mA	Typically 1	-		Typically 1	-		Typically 1	-		
PT1000 / KTY83 / KTY84 / NTC	mA	Typically 0.2	-		Typically 0.2	-		Typically 0.2	-		
Wire-break detection		No							Yes ¹⁾	Yes	
Short-circuit detection		No							Yes	No	
3-wire connection		Yes ²⁾	-		Yes ²⁾	-		Yes ²⁾	-		
Enclosure											
Environmental effects											
Permissible ambient temperature	°C	- 25° to 60°									
Permissible storage temperature	°C	- 40° to 80°									
Permissible mounting position		any									
Degree of protection to EN 60 529		Terminals: IP20; cover: IP40									
Rated insulation voltage U_i (pollution degree 3)	AC V	300									
Conductor cross-section											
Screw terminals											
- solid	mm ²	M 3.5 (for standard screwdriver Size 2 and Pozidriv 2)									
- finely stranded, with end sleeves	mm ²	1 x (0.5 to 4) / 2 x (0.5 to 2.5)									
- solid or stranded AWG conductors	AWG	1 x (0.5 to 2.5) / 2 x (0.5 to 1.5)									
- Tightening torque	Nm	2 x (20 to 14)									
		0.8 to 1.2									
Cage Clamp terminals											
- solid	mm ²	2 x (0.25 to 1.5)									
- finely stranded, with end sleeves	mm ²	2 x (0.25 to 1)									
- finely stranded, without end-sleeves	mm ²	2 x (0.25 to 1.5)									
- solid or stranded AWG conductors	AWG	2 x (24 to 16)									
- corresponding opening tool		8WA2 807									
Vibration performance IEC 68-2-6		5 to 26 Hz/0.75 mm									
Shock resistance IEC 68-2-27		15 g/11 ms									

1) Not for NTC (B57227-K333-A1 (100 °C:1.8 kΩ; 25 °C:32.762 kΩ)).

2) 2-wire connection of resistance sensors with wire jumper between T2 and T3.

3RS10/3RS11

Configuration

Specifications

The temperature monitoring relays correspond to:

- IEC 60 721-3-3 "Environmental conditions"
- IEC 947-5-1; DIN VDE 0660 "Low-voltage switchgear and controlgear"
- EN 50 081-2 "Basic technical standard for emitted interference (industry)"
- EN 61 000-6-2 "Basic technical standard for interference immunity (industry)"
- DIN EN 50 042 "Terminal marking"
- UL/CSA under application

Connection of resistance thermometers

2-wire measurement

When 2-wire temperature sensors are used, the sensor resistance is added to the wire resistance. The system error that results must be taken into

account when the parameters are set for the evaluation unit. A jumper must be clamped between terminals T2 and T3.

The following table can be used to determine the temperature error when a PT100 is used.

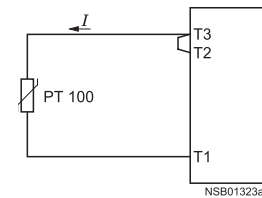

Error due to wiring

The error that arises due to the wiring is approx. 2.5 Kelvin/ohm. If the resistance of the wiring is not known and cannot be measured, the wiring error can be estimated by means of the following table.

Temperature error as a function of conductor length and cross-section with PT 100 sensors and 20°C ambient temperature, in K

Cable length in m	Cross-section mm ²			
	0.5	0.75	1	1.5
0	0.0	0.0	0.0	0.0
10	1.8	1.2	0.9	0.6
25	4.5	3.0	2.3	1.5
50	9.0	6.0	4.5	3.0
75	13.6	9.0	6.8	4.5
100	18.1	12.1	9.0	6.0
200	36.3	24.2	18.1	12.1
500	91.6	60.8	45.5	30.2

3-wire measurement

To minimise the effects of the wiring resistances, a 3-wire circuit is usually used.

Using the additional wire, it is possible for two measuring circuits to be formed of which one is used as a reference.

The evaluation unit can then automatically calculate the wiring resistance and take it into account.

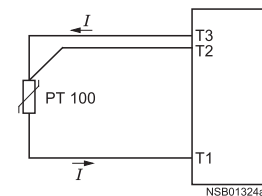

Connection of thermoelements

A differential temperature measurement is obtained from the thermo-electrical effect

between the measuring point and the evaluation unit.

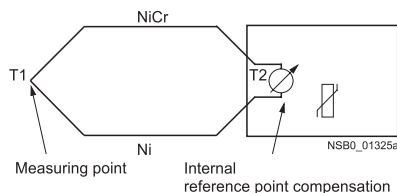

This principle assumes that the evaluation unit knows the temperature at the terminal (T2). The 3RS11 temperature monitoring relays have a built-in reference point correction function that determines this reference temperature and uses it to generate the measurement result.

The absolute temperature is therefore calculated from the ambient temperature of the evaluation unit and the temperature difference measured by the thermoelement.

In this manner, temperature acquisition (T1) is possible without knowing the precise ambient temperature at the terminals of the evaluation unit (T2).

The connecting lead is only permitted to be extended using equalising conductors made from the same material as the thermoelement itself. If a different type of lead is used, the measurement will be inaccurate.

Functions

Temperature overshoot

Open-circuit principle

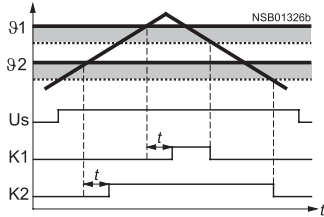

Closed-circuit principle

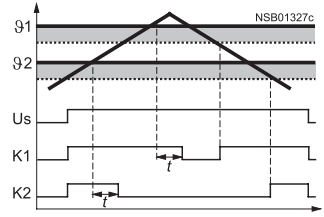

Digital evaluation units:

After the temperature has reached the set threshold value ϑ_1 , output relay K1 changes its switching state appropriately as soon as the set time t has elapsed (K2 responds to ϑ_2 similarly).

Analog evaluation units:

When the set threshold value is reached, output relay K1 changes its switching status. For devices with 2 threshold values, relay K2 responds to the second set threshold value.

As soon as the temperature reaches the respective set hysteresis value, the relays return immediately to the original state.

A time delay cannot be set ($t = 0$).

Temperature undershoot

Open-circuit principle

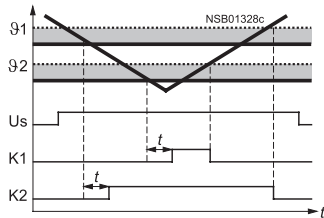

Closed-circuit principle

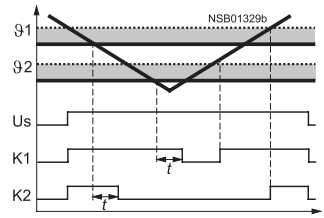

Window monitoring

Open-circuit principle

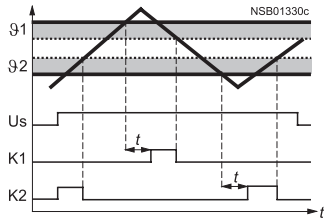

Closed-circuit principle

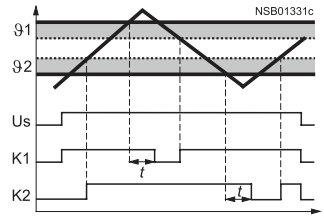

When the temperature has reached the upper threshold ϑ_1 and the set delay time t has elapsed, the output relay K1 changes its switching state. As soon as the temperature reaches the respective set hysteresis value, the relay returns immediately to the original state.

In the same manner, K2 responds to the lower threshold value of ϑ_2 .

Principle of operation with memory function, based on the example of temperature overshoot using the closed-circuit principle

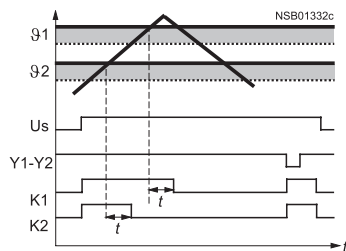

When the temperature has reached the set threshold ϑ_1 and the set delay time t has elapsed, the output relay K1 changes its switching state (similarly, K2 responds to ϑ_2 .)

The relays will only return to the original state when the temperature has fallen below the respective set hysteresis value and the connection Y1-Y2 was briefly interrupted.

- Absolute limit
 - Hysteresis range
 - Hysteresis limit
- NS500629

Function Relays, Interfaces and Converters

Temperature Monitoring Relays

SIRIUS RELAYS

3RS10/3RS11

Circuit diagrams

Connection examples

3RS10 00
3RS10 10

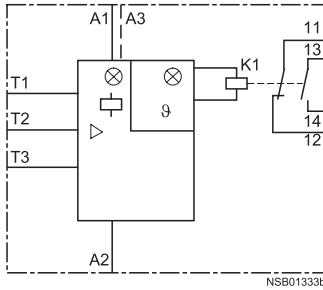

3RS11 00
3RS11 01

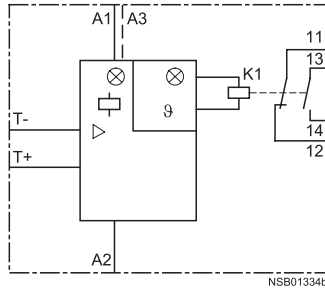

3RS10 20
3RS10 30

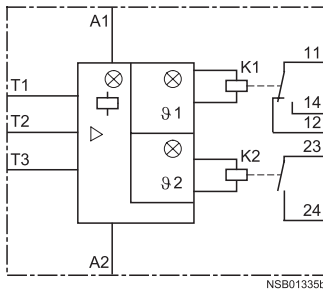

3RS11 20/3RS11 30
3RS11 21/3RS11 31

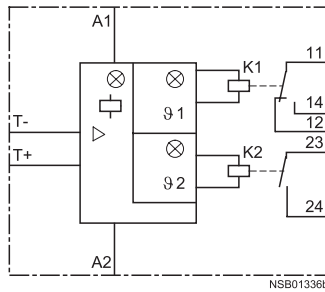

3RS10 40
3RS20 40

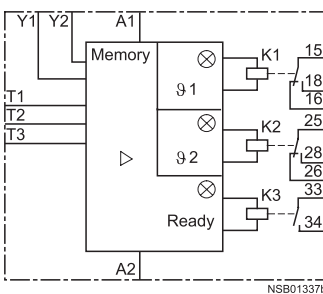

3RS10 41
3RS20 41

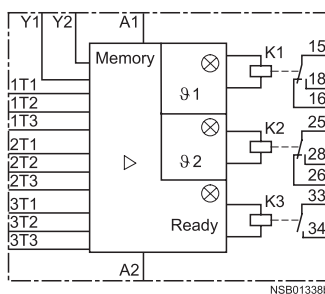

3RS11 40
3RS21 40

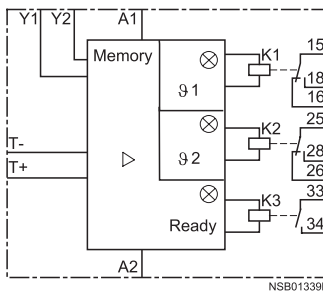

General equipment designations

A1, A2, A3 Rated control supply voltage terminals
K1, K2, K3 Output relays

Equipment designations for:
3RS1000, 3RS1010, 3RS1101, 3RS1100,
3RS1110, 3RS1111, 3RS1020, 3RS1021,
3RS1030, 3RS1031

□ = LED: "Voltage applied"
∅1 = LED: "Relay 1 switched"
∅2 = LED: "Relay 2 switched"
T1 to T3 = Terminals for connection of resistance sensor
T+ / T- = Terminals for connection of thermoelements

Equipment designations for:
3RS1040, 3RS1140, 3RS2040, 3RS2140

∅1 = LED: "Relay 1 switched"
∅2 = LED: "Relay 2 switched"
Ready = LED: "Device operating"
T1 to T3 = Terminals for connection of resistance sensor
T+ / T- = Terminals for connection of thermoelements
Y1/Y2 Terminals for memory jumper
JBiq

Equipment designations for:
3RS1041, 3RS2041

∅1 = LED: "Relay 1 switched"
∅2 = LED: "Relay 2 switched"
Ready = LED: "Device operating"

1T1 to 1T3 = Terminals for connection of resistance sensor 1
2T1 to 2T3 = Terminals for connection of resistance sensor 2
3T1 to 3T3 = Terminals for connection of resistance sensor 3
Y1/Y2 Terminals for memory jumper



Important!
When resistance sensors are used in a 2-wire connection, a jumper must be installed between T2 and T3.

SIRIUS
RELAYS

3RS10/3RS11

1
2
3
4
5
6
7
8
9
10
11

Dimension drawings

Temperature monitoring relay

3RS10/3RS11 .. with 22.5 mm enclosure

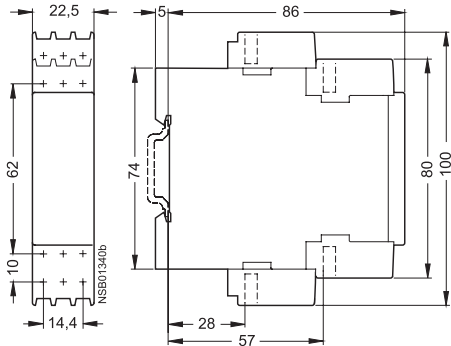

3RS20/3RS21
3RS10/3RS11 .. with 45 mm enclosure

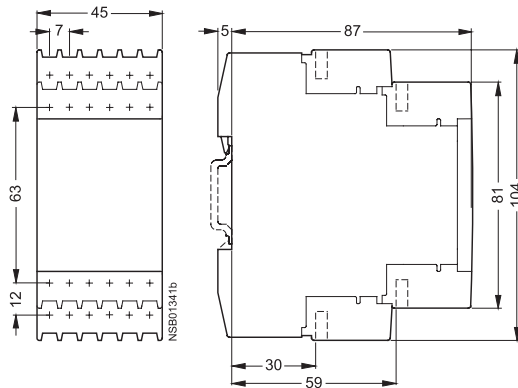

3RN1 for PTC temperature sensors

Overview

3RN10 00 compact tripping unit

The compact unit is equipped with a red LED (TRIPPED) to indicate tripping and a SPDT contact.

After the device has tripped, it is reset automatically after the thermistors have cooled down. The common contact of the SPDT contact is connected to the control voltage

This device is particularly suitable in circuits in which the control circuit and signalling circuit are at the same potential, e.g. in local control boxes.

3RN10 10, 10 11, 10 12 standard tripping unit

The standard units are equipped with two LEDs (READY and TRIPPED) and with 1NO and 1NC for switch-off and signalling. They are available with automatic RESET (3RN10 10), manual RESET (3RN10 11) or manual/automatic and remote RESET (3RN10 12). The 3RN10 12 unit holds on supply failure. If the control voltage fails, a previous trip will be memorised.

A remote RESET function is implemented by connecting an external pushbutton with an NO contact to terminals Y1 and Y2. If terminals Y1 and Y2 are bridged, tripping is followed by an automatic RESET.

3RN10 13 multifunction tripping unit

In the 3RN10 13 thermistor motor protection tripping units, the sensor circuit is also monitored for a short circuit. Tripping due to a short circuit is indicated by a flickering red LED. The monostable design also indicates a wire-break in the sensor circuit by flashing of the red LED. The 3RN10 13 tripping unit is equipped with manual, remote and automatic RESET functions. The TEST/RESET button can be used to manually reset the tripping unit.

A remote RESET function is implemented by connecting an external pushbutton with an NO contact to terminals Y1 and Y2. If terminals Y1 and Y2 are bridged, tripping is followed by an automatic RESET.

Response of the tripping unit to failure of the control voltage

Response	Monostable 3RN10 00 3RN10 10 3RN10 11	Holding on supply failure	
		Monostable 3RN10 12 3RN10 13-... 0 3RN10 22 3RN10 62	Bistable 3RN10 13-... 01
at			
Failure of the control voltage	Device trips	Device trips	No change in switching status of the auxiliary contacts
Control voltage returns without previous tripping	Device resets	Device resets	
Control voltage returns after tripping	Device resets	Device remains tripped	

3RN10 22 tripping unit "Warning and switch-off"

Two sensor circuits can be connected to one 3RN10 22 tripping unit and act on one output relay with 1 NO for warning and 1 SPDT for switch-off. The functions "Warning" and "Switch-off" are implemented by means of temperature sensors with different rated response temperatures TNF. Activation of the sensor circuit for "Warning" is indicated by a yellow LED and for "Switch-off" by a red LED.

The sensor circuits have different reset responses:

- "Warning" (terminals 2T1, T2) automatic RESET only
- "Switch-off" (terminals 1T1, T2); changeover from manual RESET to automatic RESET by bridging terminals Y1 and Y2. A remote RESET function is implemented by connecting an external pushbutton with an NO contact.

3RN10 62 tripping unit "Multiple motor protection"

Up to six sensor circuits can be connected to one 3RN10 62 tripping unit which all act on one output relay. Simultaneous protection of several motors (up to 6) is an advantage in the case of group drives (e.g. if a motor is overloaded, all motors in the group can be switched off). Apart from the red LED "TRIPPED" that indicates the switching status of the tripping unit, a LED is assigned to each sensor circuit that is lit when the associated sensor circuit trips. Sensor circuits that are not required must be short circuited.

The reset response of the 3RN10 62 tripping units can be changed from manual RESET to automatic RESET by bridging terminals Y1 and Y2. A remote RESET function is implemented by connecting an external pushbutton with an NO contact.

3RN10 12-2C...

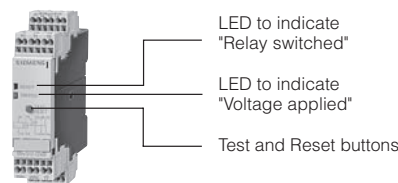

control circuit and sensor circuit in the case of AC and UC control supply voltages (for DC control supply voltage: no electrical isolation). For units with a TEST button, the function of the device can be checked by pressing the button for longer than 2 s.

Safe electrical isolation

All electrical circuits (outputs, control circuit, sensor and Reset circuit) of the 3RN1013-1BW10 multifunction tripping unit (wide input voltage range, monostable output relay and screw terminals) are safely isolated from each other up to a rated voltage of 300 V acc. to DIN VDE 0100 Part 410/ DIN VDE 0106/DIN VDE 0160.

Application

The 3RN1 thermistor motor protection tripping units are thermal protective devices that can be used in conjunction with PTC thermistors Type A for the temperature monitoring of electrical drives, transformer windings, oils, bearings, air, etc.

Principle of operation

The 3RN1 tripping units operate according to the closed-circuit principle and therefore monitor themselves for a wire-break. A temporary voltage drop of less than 200 ms (for devices with a wide input voltage range < 100 ms) will not cause a change in status of the auxiliary contacts. The 3RN10 13 multifunction tripping unit also features short-circuit detection in the sensor circuit. The unit will trip if a short circuit arises in the sensor circuit (resistance in sensor circuit < 20 Ω). The tripping units feature electrical isolation between the

Notes

- ⚠ For DC-activated tripping units, electrical isolation must be provided using a battery system or a safety isolating transformer to DIN VDE 0551.
- ⚠ When tripping units with an automatic RESET function are used in EEx e zones, the control circuit must be designed to ensure that the monitored machine cannot restart autonomously.
- ⚠ In the case of tripping units without short-circuit detection, the sensor circuit must be measured with a suitable measuring instrument during commissioning. For resistance < 50 Ohm, the sensor circuit must be checked for a short circuit.
- ⚠ When the 3RN10 00 unit (no Ready LED) and the 3RN10 13-1BW01 unit (no change in switching status for the auxiliary contacts on control voltage failure) are used to protect EEx e motors, separate monitoring of the control voltage is recommended.

Thermistor motor protection relays for PTC thermistors (type A PTCs)					
All of the devices with the exception of 24 V AC/DC have electrical isolation					
Version	Reset	Contacts	Control supply voltage	Order No..	List Price \$
Compact evaluation units, 22.5 mm wide, monostable, closed-circuit current principle, 1 LED					
Terminal A1 is connected to the common of the changeover contact	Auto	1 CO	24 V AC/DC	3RN1000-□AB00	
			110 V AC	3RN1000-□AG00	
			230 V AC	3RN1000-□AM00	
Standard evaluation units, 22.5 mm wide, monostable, closed-circuit current principle, 2 LEDs					
Short-circuits are detected in the sensor circuit	Auto	1 NO + 1 NC	24 V AC/DC	3RN1010-□CB00	
			110 V AC	3RN1010-□CG00	
			230 V AC	3RN1010-□CM00	
			24–240 V AC/DC	3RN1010-□CW00	
		2 CO	24 V AC/DC	3RN1010-□BB00	
			110 V AC	3RN1010-□BG00	
	2 CO hard-gold-plated	230 V AC 230 V	3RN1010-□BM00		
		24 V AC/DC	3RN1010-□GB00		
	Manual/remote ³⁾	1 NO + 1 NC	24 V AC/DC	3RN1011-□CB00	
			110/230 V AC	3RN1011-□CK00	
			24 V AC/DC	3RN1011-□BB00	
		2 CO	110 V AC	3RN1011-□BG00	
230 V AC			3RN1011-□BM00		
2 CO hard-gold-plated		24 V AC/DC	3RN1011-□GB00		
Holding on supply failure ²⁾	Manual/auto/remote	1 N + 1 NC	24 V AC/DC	3RN1012-□CB00	
			110/230 V AC	3RN1012-□CK00	
		2 CO	24 V AC/DC	3RN1012-□BB00	
	2 CO hard-gold-plated	110 V AC	3RN1012-□BG00		
		230 V AC	3RN1012-□BM00		
	Holding on supply failure ²⁾ , short-circuits are detected in the sensor circuit	Manual/auto/remote	2 CO	24 V AC/DC	3RN1012-□BB00
110 V AC				3RN1012-□BG00	
230 V AC			3RN1012-□BM00		
2 CO hard-gold-plated		24 V AC/DC	3RN1012-□GB00		
		24 V AC/DC	3RN1013-□BB00		
		24–240 V AC/DC	3RN1013-1BW10		
2 CO hard-gold-plated	24–240 V AC/DC	3RN1013-2BW00			
	24–240 V AC/DC	3RN1013-1GW10			
24–240 V AC/DC	3RN1013-2GW00				
Evaluation units for 2 sensor circuits, alarm and trip, 22.5 mm wide, monostable, closed-circuit current principle, 3 LEDs					
Test/reset button, holding on supply failure ²⁾ ; the evaluation circuit for “alarm” uses an NO contact in the open-circuit principle	Manual/auto/remote	1 NO + 1 NC	24–240 V AC/DC	3RN1022-□DW00	
Evaluation units for 6 sensor circuits, multi-motor protection, 45 mm wide, monostable, closed-circuit current principle, 8 LEDs					
Test/reset button, holding on supply failure ²⁾	Manual/auto/remote	1 NO + 1 NC	24–240 V AC/DC	3RN1062-□CW00	
Test/reset button, holding on supply failure ²⁾ , short-circuits and wire breakage in the sensor circuit are detected and displayed, bistable version, not tripped when the control supply voltage fails	Manual/auto/remote	2 CO	24–240 V AC/DC	3RN1013-□BW01	

¹⁾ Protective separation up to 300 V according to DIN/VDE 0106

²⁾ Information regarding the holding on supply failure, refer to Catalog LV 1, chapter 7

³⁾ Reset using the reset button or by interrupting the control supply voltage

Screw Terminal **1**

Spring-type Terminal **2**

Function Relays, Interfaces and Converters

Thermistor Motor Protection

SIRIUS
RELAYS

3RN1
for PTC temperature sensors

Accessories

Design	for type	Order No.	Weight approx. kg	Packing Packs
--------	----------	-----------	----------------------	------------------

Push-in lugs for panel mounting



2 units are necessary per thermistor motor protection.
1 pack contains 10 units for 5 devices.

3RN1

3RP 1903

0.02

1

Technical data

General data

		Compact devices				Standard devices			Multifunct. dev.	Warning + switch-off	Multiple mot. protect.
		3RN10 00	3RN10 10	3RN10 11	3RN10 12	3RN10 13	3RN10 22	3RN10 62			
Type		3RN10 00	3RN10 10	3RN10 11	3RN10 12	3RN10 13	3RN10 22	3RN10 62			
Width	mm	22.5							45		
No. of connectable sensor circuits		1						2	6		
Response to failure of the control voltage		1)									
Manual RESET		No			Yes						
Automatic RESET		Yes		No			Yes				
Remote RESET		No			Yes ²⁾		Yes				
TEST button		No			Yes						
Short-circuit detection in sensor circuit		No					Yes		No		
Indication of short-circuit and wire-break		No					Yes ³⁾		No		
Warning and switch-off in one unit		No						Yes		No	
Weight	kg	0.120	0.133	0.145	0.145	0.145	0.145	0.145	0.260		

Tripping unit

Rated insulation voltage U_i (pollution degree 3)	V	300
Permissible ambient temperature	°C	-25 to +60
Permissible storage temperature		-40 to +80
EMC tests		EN 50 081-2; IEC 61000-6-3
Class acc. to DIN 19 251, DIN V0801		AK 3
Degree of protection acc. to DIN 40 050		IP 20
Conductor cross-section		
Terminal screws		M 3.5 (for standard screwdriver Size 2 and Pozidriv 2)
• Solid	mm ²	1 x (0.5 to 4) / 2 x (0.5 to 2.5)
• Finely stranded with end sleeves	mm ²	1 x (0.5 to 2.5) / 2 x (0.5 to 1.5)
• AWG conductor connections, solid or stranded	AWG	2 x (20 to 14)
• Tightening torque	Nm	0.8 to 1.2
Cage Clamp terminals		
• Solid	mm ²	2 x (0.25 to 1.5)
• Finely stranded with end sleeves	mm ²	2 x (0.25 to 1)
• Finely stranded, without end sleeves	mm ²	2 x (0.25 to 1.5)
• AWG wires, solid or stranded	AWG	2 x (24 to 16)
• Corresponding opening tool		8WA2 803

Sensor circuit

Circuit burden at $R_F \leq 1.5 \text{ k}\Omega$	mW	≤ 5
Voltage in sensor circuit at $R_F \leq 1.5 \text{ k}\Omega$	V	≤ 2
Tripping temperature (specified by sensor)	°C	60 to 180
Coupling time (due to mounting of sensor)	s	approx. 5 s
Total cold resistance R_F (per sensor loop)	k Ω	≤ 1.5
Triggering value	k Ω	3.4 to 3.8
Return value	k Ω	1.5 to 1.65
Triggering tolerance	°C	± 6

1) See page 11/12.

2) Remote RESET due to interruption of the control voltage.

3) Indication of wire-break only for monostable designs (3RN10 13-...0).

Technical data								
Type	Compact devices		Standard devices			Multi-function devices	Warning + switch-off	Multiple motor protection
	3RN10 00	3RN10 10	3RN10 11	3RN10 12	3RN10 13	3RN10 22	3RN10 62	
Control circuit								
Rated control supply voltage U_s	1)							
Operating range	<ul style="list-style-type: none"> AC: 0.85 to 1.1 x U_s AC/DC: 0.85 to 1.1 x U_s DC: 0.85 to 1.2 x U_s 							
Rated power	<ul style="list-style-type: none"> AC: W < 2 AC/DC: W < 2 DC: W < 2 							
Auxiliary circuit								
Conventional free-air thermal current I_{th}	A	5						
Rated operational current I_e	<ul style="list-style-type: none"> AC-15 240 V: A 3 DC-13 24 V: A 1 2 1²⁾ 1 2 							
Short-circuit protection acc. to Alpha/Lovag	Utilisation category gL/gG							
Ⓢ and Ⓢ ratings, control current circuit								
Rated control voltage	50/60 Hz							
<ul style="list-style-type: none"> AC: V 300 DC: V 300 								
Switching capacity	R 300/B 300							
Safe isolation up to 300 V	-					3RN10 13-1BW10	-	

Functions
Function diagrams

3RN10 00/3RN10 10
(AUTO RESET)

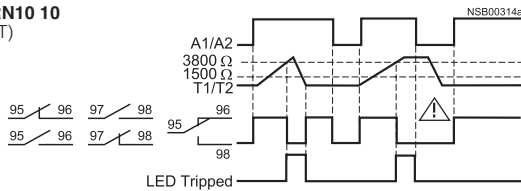

3RN10 11

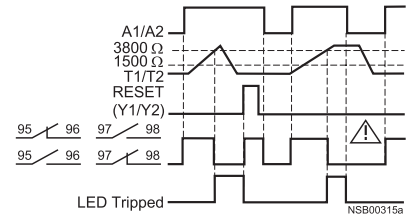

3RN10 13-...01
(bistable)

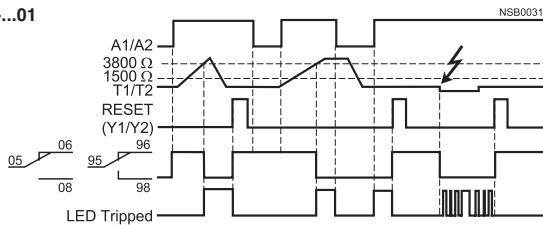

3RN10 12/3RN 1022/3RN10 62
(holding on supply failure)

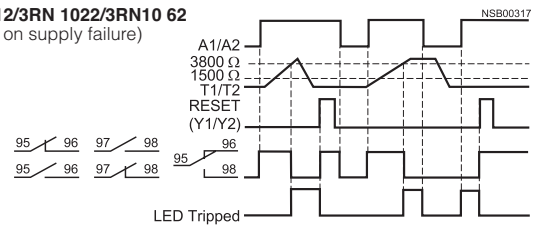

3RN10 13-...0

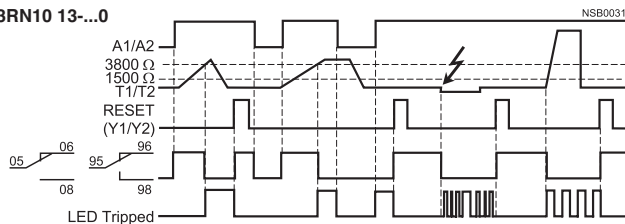

3RN10 22 only

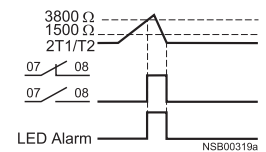

1) See selection and ordering data, page 11/13
2) For 3RN10 13- .BW01 (bistable output relay) 2 A.

See notes on page 11/12.

3RN1 for PTC temperature sensors

Configuration

PTB test report ATEX certification

The tripping units with AC and UC operation are available in conjunction with PTC thermistors acc. to DIN VDE 0660 Parts 302 and 303 and DIN 44 081/DIN 40 082 for direct temperature monitoring of explosion-protected motors of the "Increased safety" EEx e and EEx d degree of protection and are marked with the test symbol. The regulations of DIN EN 50 019, DIN VDE 0170/0171, DIN VDE 0165, the PTB test regulations DIN V 0801 Class = AK 3 and DIN 19251 apply. For tripping units with DC operation¹⁾, electrical isolation must be implemented by means of a battery system or a safety isolating transformer acc. to DIN VDE 0551.

When the 3RN10 13-...01 unit (no change in switching status for the auxiliary contacts on control voltage failure) is used to protect EEx e and EEx d motors, separate monitoring of the control voltage is recommended.

PTB File No. for 3RN1:
PTB 01 ATEX 3218

Cable routing

The measuring circuit cables must be routed as separate control cables. It is not permitted to use cores of the motor supply cable or other main supply cables. If extreme inductive or capacitive interference is expected to be generated by heavy current cables routed in parallel, shielded control cables must be used.

Maximum cable length for sensor circuit:

Cross-section	For tripping units	
	3RN10 00	3RN10 13
	3RN10 10	
	3RN10 11	
	3RN10 12	
	3RN10 22	
	3RN10 62	
mm ²	m	m ²
2.5	2 x 2800	2 x 250
1.5	2 x 1500	2 x 150
0.5	2 x 500	2 x 50

PTC temperature sensor

With the tripping units, temperature sensors with characteristics according to DIN VDE 0660 Part 303, DIN 44 081 and DIN 44 082 (e. g. EPCOS AG single and triple sensors, Type No. B 591... or B 593...) can be used.

The number of temperature sensors that can be connected in series is dependent on the total cold resistance. The total cold resistance must not exceed 1.5 kΩ.

Resistance/temperature characteristic of a PTC thermistor

with a characteristic (Type A) according to DIN VDE 0660 Part 303

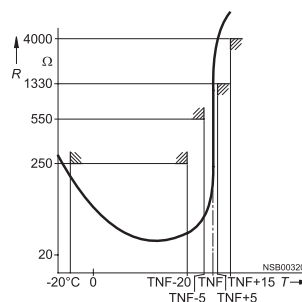

Installation

The 3RN1 tripping units are suitable for snapping on to 35 mm standard mounting rails acc. to DIN EN 50 022 or for screw mounting using adapters. Any mounting position is possible.

Specifications

The tripping units are suitable for use in any climate and safe from touch to DIN VDE 0106 Part 100.

The 3RN1 tripping units meet the requirements of the basic technical standard EN 50 081-2; IEC 61000-6-2 "Electromagnetic compatibility of I&C equipment in industrial process engineering" and DIN VDE 0660 Parts 302 and 303, IEC 60 034-11-2 Section 1 and 2 "Built-in thermal protection of rotating electrical machines, thermal detectors and tripping units" and "PTC thermistors and tripping units".

The terminal designations of the auxiliary contacts complies with EN 50 005.

Protecting the windings of three-phase transformers

To protect the windings of three-phase dry transformers with PTC thermistors in cases where the operating voltage of the thermistor motor protection tripping unit must be tapped from the mains voltage, a 3RN10 22 thermistor protection unit for warning and tripping and, for example, a 3RP15 time relay can be used. The auxiliary contactor K4 operates on the shunt release of the high-voltage circuit-breaker.

Working principle for transformer protection

When voltage is applied to the line-side of the transformer, the voltage on the secondary side rises to the final value within 1.5 s. The 3RN1 tripping unit does not trip until $0.8 \times U_s$, so as long as the operating voltage is applied to the closed contacts 95-98 on contactor K4, it would cause breaking of the

circuit-breaker via its shunt release.

In order to prevent this, the voltage is only applied to terminals 07 and 95 once the 3RN1 tripping units have definitely picked up and the auxiliary switches have switched to the "Ready" position. The K3 and K4 contactors are not controlled until the respective rated response temperature TNF of the sensor is exceeded.

The tripping unit should be switched to "Automatic RESET" (jumper must be placed between terminals Y1 and Y2). This ensures that the 3RN1 tripping unit is reset when the transformer is reconnected following tripping. The time-delay relay is set to a delay time of ≥ 1.5 s.

Transformer protection with 3RN10 22 (shown before voltage is applied)

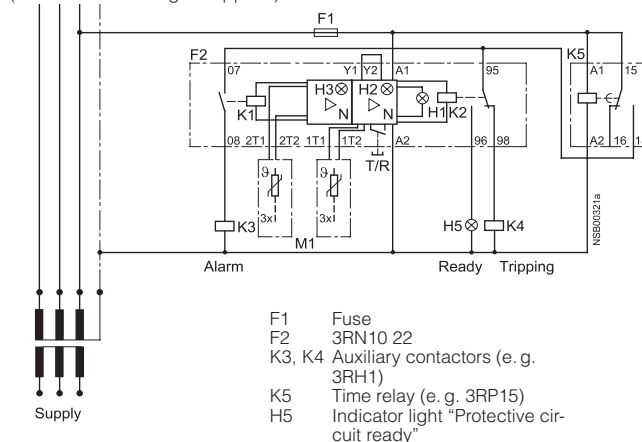

- F1 Fuse
- F2 3RN10 22
- K3, K4 Auxiliary contactors (e. g. 3RH1)
- K5 Time relay (e. g. 3RP15)
- H5 Indicator light "Protective circuit ready"

- 1) Electrical isolation exists with devices with a wide input voltage range of 24 to 240 V UC even in the case of DC operation.
- 2) Devices with short-circuit detection in the sensor circuit. Up to this maximum cable length, a short-circuit in the sensor circuit will be detected. When short-circuit detection is not required, the cable lengths shown on the left can be used.

Circuit diagrams

Connection diagrams

Position of the output relay "Ready, not tripped"

3RN10 00

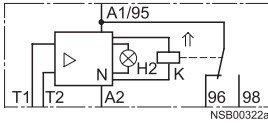

3RN10 10

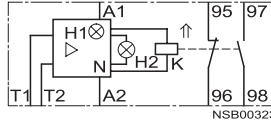

3RN10 11¹⁾

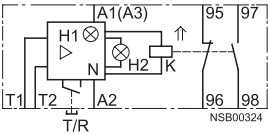

3RN10 12¹⁾

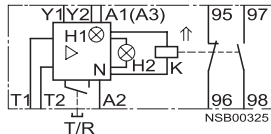

3RN10 13-... 0

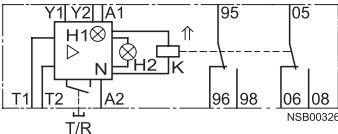

3RN10 13-... 1 (bistable)

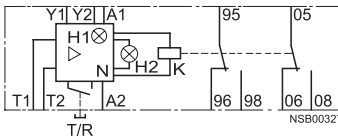

3RN10 22

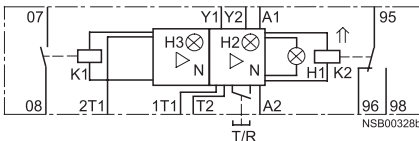

3RN10 62

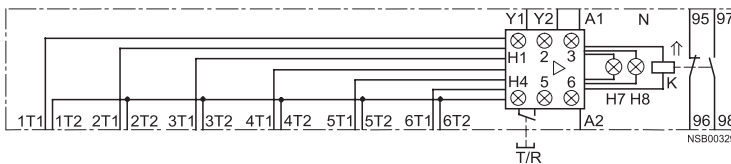

General equipment designations

- A1, A2 Control voltage terminals
- N Amplifier
- T/R TEST/RESET button
- Y1, Y2 Terminals for remote RESET (jumped = Auto RESET)
- ↑ The double-headed arrow indicates an operating state of the contact element that deviates from the standard presentation according to DIN 40 900, Part 7 (In this case: Position of the contact elements when the control voltage is applied to terminals A1 and A2)

Equipment designations for 3RN10

- H1 LED "READY"
- H2 LED "TRIPPED"
- K Output relay
- T1, T2 Terminals of the sensor loop

Equipment designations for 3RN10 22

- H1 LED "READY"
- H2 LED "TRIPPED"
- H3 LED "ALARM"
- K1, K2 Output relay
- 1T1 and T2 Terminals of the sensor
- 2T1 and T2 loop



Sensor circuits that are not connected must be short circuited.

Equipment designations for 3RN10 62

- H1 to H6 LEDs for tripped sensor loops
- H7 LED "READY"
- H8 LED "TRIPPED"
- K Output relay
- 1T1, 1T2 Terminals for 1st sensor loop
- 6T1, 6T2 Terminals for 6th sensor loop



Sensor circuits that are not connected must be short circuited.

1) For dual voltage devices AC 230 V/110 V (3RN10 11- .CK00 and 3RN10 12- .CK00):
A1 and A2: AC 230 V,
A3 and A2: AC 110 V.

Function Relays, Interfaces and Converters

Thermistor Motor Protection

SIRIUS
RELAYS

3RN1
for PTC temperature sensors

Circuit diagrams

Connection examples

3RN10 00 tripping unit

Switching off a three-phase motor via a contactor, pushbutton control

- The contact elements are shown for voltage applied to terminals A1 and A2 of the tripping unit

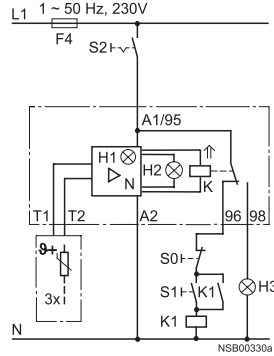

3RN10 11 tripping unit

Switching off a three-phase motor via a contactor, maintained-contact control

- The contact elements are shown for voltage applied to terminals A1 and A2 of the tripping unit

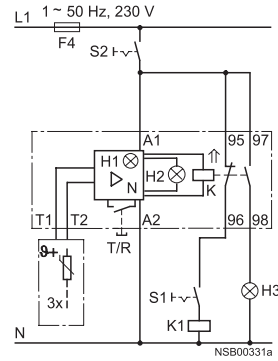

3RN10 12 tripping unit

Switching off a three-phase motor via a contactor, pushbutton control

- The contact elements are shown for voltage applied to terminals A1 and A2 of the tripping unit

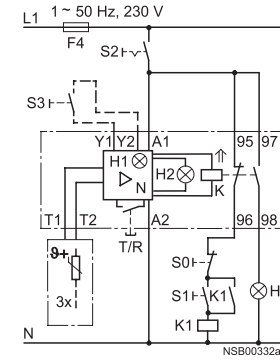

General equipment designations

A1, A2	Control voltage terminals ¹⁾
F4	Back-up fuse
N	Amplifier
S0	OFF pushbutton
S1	ON pushbutton
S2	Main switch
S3	Remote RESET button
T/R	TEST/RESET button
Y1, Y2	Terminals for remote RESET (jumpered = Auto RESET)
↑	The double-headed arrow indicates an operating state of the contact element that deviates from the standard presentation according to DIN 40 900, Part 7 (In this case: Position of the contact elements when the control voltage is applied to terminals A1 and A2)

Equipment designations for 3RN10

H1	LED "READY"
H2	LED "TRIPPED"
H3	Signalling light
K	Output relay
K1	Contactor
1T, T2	Terminals of the sensor loop

Equipment designations for 3RN10 22

H1	LED "READY"
H2	LED "TRIPPED"
H3	LED "ALARM"
H4	Signalling light
H5	Signalling light "ALARM"
K1, K2	Output relay
K3	Contactor
1T1 and T2	Terminals of the sensor
2T1 and T2	loop

⚠ *Sensor circuits that are not connected must be short circuited.*

3RN10 13-...0 tripping unit

Switching off a three-phase motor via a contactor, pushbutton control

- The contact elements are shown for voltage applied to terminals A1 and A2 of the tripping unit

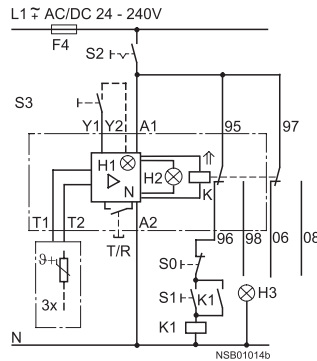

3RN10 22 tripping unit (warning + switch-off)

Switching off a three-phase motor via a contactor, warning via output relay, pushbutton control

- The contact elements are shown for voltage applied to terminals A1 and A2 of the tripping unit

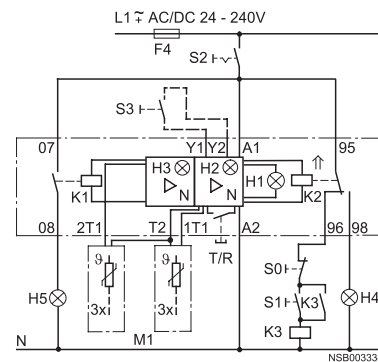

3RN10 62 tripping unit (multiple motor protection)

Switching off 6 three-phase motors via contactors, pushbutton control

- The contact elements are shown for voltage applied to terminals A1 and A2 of the tripping unit

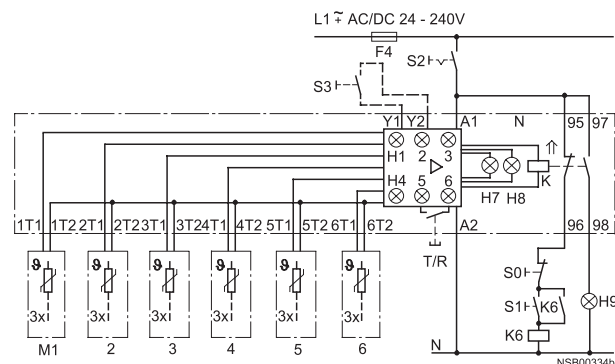

Equipment designations for 3RN10 62

H1 to H6	LEDs for tripped sensor loops
H7	LED "READY"
H8	LED "TRIPPED"
H9	Signalling light
K	Output relay
K6	Contactor
1T1, 1T2 to 6T1, 6T2	Terminals for 1st sensor loop to 6th sensor loop

⚠ *Sensor circuits that are not connected must be short circuited.*

- For dual voltage devices AC 230 V/110 V (3RN10 11-..CK00 and 3RN10 12-..CK00): A1 and A2: AC 230 V, A3 and A2: AC 110 V.

Dimension drawings

3RN10 00

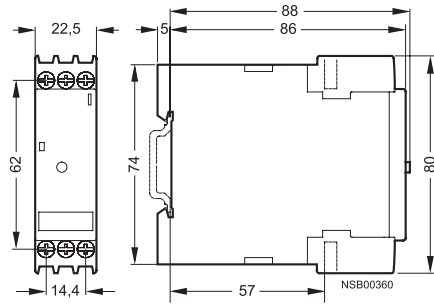

3RN10 10

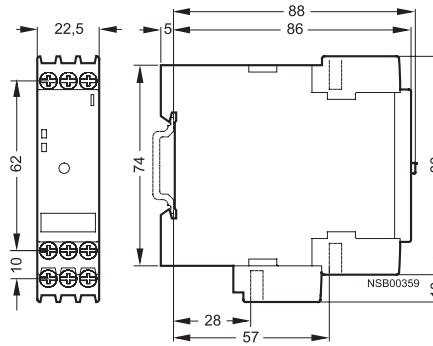

3RN10 11, 3RN10 12, 3RN10 13, 3RN10 22

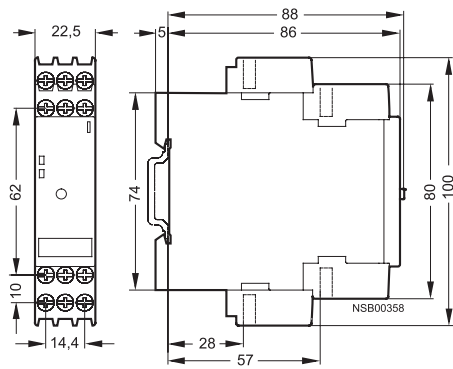

3RN10 62

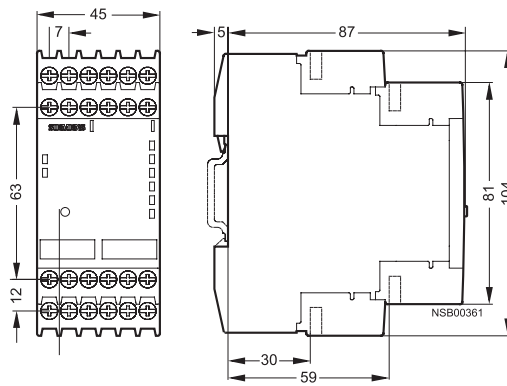

3RP20 / 3RP15

Overview

3RP20 time relay, assembly width 45 mm

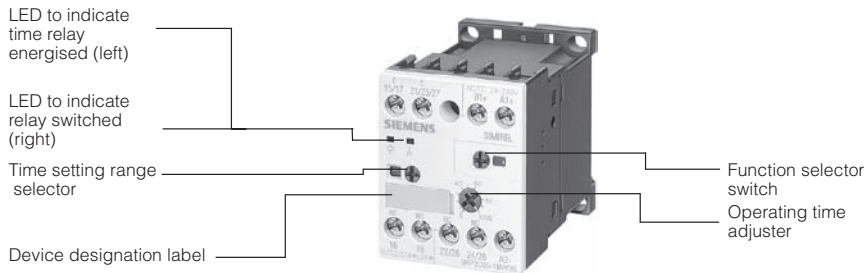

Accessories

Push-in lugs for screw fixing



Sealable cap



3RP15 time relay, assembly width 22.5 mm

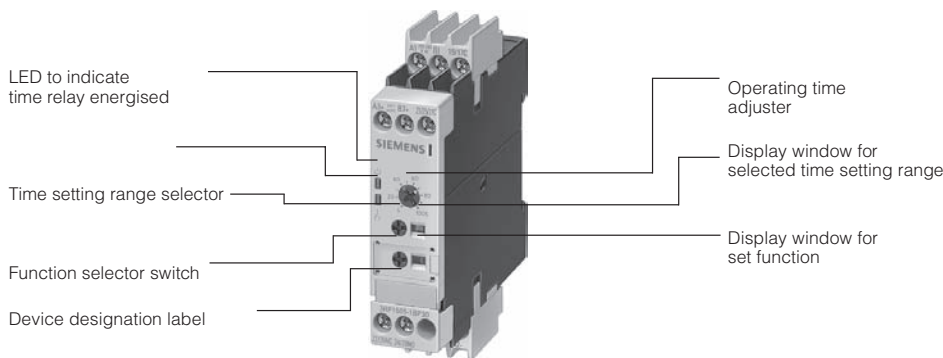

Function

Standards, specifications

- The time relays comply with:
- IEC 60 721-3-3 "Environmental conditions"
 - IEC 61 812-1/DIN VDE 0435 Part 2021 "Electrical relays, time relays"
 - IEC 61 000-6-2/EN 50 081-1 "Electromagnetic capability"
 - IEC 60 947-5-1; DIN VDE 0660 Part 200 "Low-voltage switchgear and controlgear"

They guarantee a high level of functionality and a high repeat accuracy of timer settings.

Housing design

All time relays are suitable for snap-on mounting onto 35 mm standard mounting rails according to EN 50 022 or for screw fixing.

Configuration

- Changing the time setting ranges and the functions will only be effective when being carried out in de-energised state
- Start input B1 or B3 must only be triggered when the supply voltage is applied

- The same potential must be applied to A1 and B1, or A3 and B3
With the two-voltage version, only one voltage range must be connected
- The activation of loads parallel to the start input is not permissible when using AC control voltage (see adjacent diagrams)
- Surge suppression is integrated in the time relay. This prevents supply voltage spikes occurring when the relay switches. No damping mechanisms have been integrated for the contacts
- The 3RP15 05-.R should not be used near heat sources > 60 °C

Parallel load on start input

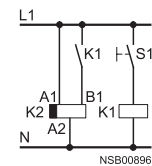
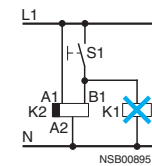

Application

Time relays are used in control, starting protective and control circuits for all switching operations involving time delays.

3RP1/3RP2 Time relays – electronic 3RP20 Time relays in the SIRIUS design, 45 mm

Function	Contact elements	Time range	Control supply voltage	Order No.	List Price \$
8 functions	1 CO (changeover contact)	0.05 s–100 h	AC/DC 24/100–127 V AC	3RP2005-□AQ30	
8 functions	1 CO	0.05 s–100 h	AC/DC 24/200–240 V AC	3RP2005-□AP30	
On delay	1 CO	0.05 s–100 h	AC/DC 24/100–127 V AC	3RP2025-□AQ30	
On delay	1 CO	0.05 s–100 h	AC/DC 24/200–240 V AC	3RP2025-□AP30	
16 functions	2 CO	0.05 s–100 h	24–240 V AC/DC	3RP2005-□BW30	

3RP1/3RP2 Time relays – electronic 3RP15 Time relays in an industrial housing, 22.5 mm

8 functions	1 CO (changeover contact)	0.05 s–100 h	12 V DC	3RP1505-□AA40	
8 functions	1 CO	0.05 s–100 h	AC/DC 24/100–127 V AC	3RP1505-□AQ30	
8 functions	1 CO	0.05 s–100 h	AC/DC 24/200–240 V AC	3RP1505-□AP30	
8 functions	1 CO	0.05 s–100 h	24–240 V AC/DC	3RP1505-□AW30	
8 functions	2 CO	0.05 s–100 h	24–240 V AC/DC	3RP1505-□RW30 ¹⁾	
16 functions	2 CO	0.05 s–100 h	AC/DC 24/100–127 V AC	3RP1505-□BQ30	
16 functions	2 CO	0.05 s–100 h	AC/DC 24/200–240 V AC	3RP1505-□BP30	
16 functions	2 CO	0.05 s–100 h	24–240 V AC/DC	3RP1505-□BW30	
16 functions	2 CO	0.05 s–100 h	400–440 V AC	3RP1505-1BT20 ²⁾	
On delay	1 CO	0.5–10 s	AC/DC 24/100–127 V AC	3RP1511-□AQ30	
On delay	1 CO	0.5–10 s	AC/DC 24/200–240 V AC	3RP1511-□AP30	
On delay	1 CO	1.5–30 s	AC/DC 24/100–127 V AC	3RP1512-□AQ30	
On delay	1 CO	1.5–30 s	AC/DC 24/200–240 V AC	3RP1512-□AP30	
On delay	1 CO	5–100 s	AC/DC 24/100–127 V AC	3RP1513-□AQ30	
On delay	1 CO	5–100 s	AC/DC 24/200–240 V AC	3RP1513-□AP30	
On delay	1 CO	0.05 s–100 h	AC/DC 24/100–127 V AC	3RP1525-□AQ30	
On delay	1 CO	0.05 s–100 h	AC/DC 24/200–240 V AC	3RP1525-□AP30	
On delay	2 CO	0.05 s–100 h	42–48/60 V AC/DC	3RP1525-□BR30	
On delay	2 CO	0.05 s–100 h	AC/DC 24/100–127 V AC	3RP1525-□BQ30	
On delay	2 CO	0.05 s–100 h	AC/DC 24/200–240 V AC	3RP1525-□BP30	
On delay	2 CO	0.05 s–100 h	24–240 V AC/DC	3RP1525-□BW30	
On delay, 2-wire	1 NO contact, solid-state	0.05–240 s	24–66 V AC/DC	3RP1527-□EC30	
On delay, 2-wire	1 NO contact, solid-state	0.05–240 s	90–240 V AC/DC	3RP1527-□EM30	
Off delay with auxiliary voltage	1 CO	0.5–10 s	AC/DC 24/100–127 V AC	3RP1531-□AQ30	
Off delay with auxiliary voltage	1 CO	0.5–10 s	AC/DC 24/200–240 V AC	3RP1531-□AP30	
Off delay with auxiliary voltage	1 CO	1.5–30 s	AC/DC 24/100–127 V AC	3RP1532-□AQ30	
Off delay with auxiliary voltage	1 CO	1.5–30 s	AC/DC 24/200–240 V AC	3RP1532-□AP30	
Off delay with auxiliary voltage	1 CO	5–100 s	AC/DC 24/100–127 V AC	3RP1533-□AQ30	
Off delay with auxiliary voltage	1 CO	5–100 s	AC/DC 24/200–240 V AC	3RP1533-□AP30	
Off delay without auxiliary voltage	1 CO	0.05–600 s	24 V AC/DC	3RP1540-□AB31	
Off delay without auxiliary voltage	1 CO	0.05–600 s	100–127 V AC/DC	3RP1540-□AJ31	
Off delay without auxiliary voltage	1 CO	0.05–600 s	200–240 V AC/DC	3RP1540-□AN31	
Off delay without auxiliary voltage	1 CO	0.05–600 s	24–240 V AC/DC	3RP1540-□AW31	
Off delay without auxiliary voltage	2 CO	0.05–600 s	24 V AC/DC	3RP1540-□BB31	
Off delay without auxiliary voltage	2 CO	0.05–600 s	100–127 V AC/DC	3RP1540-□BJ31	
Off delay without auxiliary voltage	2 CO	0.05–600 s	200–240 V AC/DC	3RP1540-□BN31	
Off delay without auxiliary voltage	2 CO	0.05–600 s	24–240 V AC/DC	3RP1540-□BW31	
Clock-pulse relay	1 CO	0.05 s–100 h	42–48/60 V AC/DC	3RP1555-□AR30	
Clock-pulse relay	1 CO	0.05 s–100 h	AC/DC 24/100–127 V AC	3RP1555-□AQ30	
Clock-pulse relay	1 CO	0.05 s–100 h	AC/DC 24/200–240 V AC	3RP1555-□AP30	
Star/delta with run-on function	3 x 1 NO contact	1–20 s, 30–600 s (run-on)	AC/DC 24/100–127 V AC	3RP1560-□SQ30	
Star/delta with run-on function	3 x 1 NO contact	1–20 s, 30–600 s (run-on)	AC/DC 24/200–240 V AC	3RP1560-□SP30	
Star/delta	1 NO contact + 1 NO contact	1–20 s	AC/DC 24/100–127 V AC	3RP1574-□NQ30	
Star/delta	1 NO contact + 1 NO contact	1–20 s	AC/DC 24/200–240 V AC	3RP1574-□NP30	
Star/delta	1 NO contact + 1 NO contact	3–60 s	AC/DC 24/100–127 V AC	3RP1576-□NQ30	
Star/delta	1 NO contact + 1 NO contact	3–60 s	AC/DC 24/200–240 V AC	3RP1576-□NP30	

¹⁾ Positively-driven and hard-gold-plated relay contacts

²⁾ This device is only available with screw terminals

Screw Terminal **1**
Spring-type Terminal **2**

Function Relays, Interfaces and Converters

Solid-State Time Relays

SIRIUS
RELAYS

3RP20/3RP15/7PV

Technical data acc. to IEC 61 812-1/DIN VDE 0435 Part 2021

Type		3RP20 05 3RP20 25	3RP15 05 3RP15 31 3RP15 32 3RP15 33	3RP15 11 3RP15 12 3RP15 13 3RP15 25 3RP15 55	3RP15 40	3RP15 60	3RP15 74 3RP15 76	3RP15 27	
Rated insulation voltage Pollution degree 3 Overvoltage category III acc. to DIN VDE 0110	AC V	300; 500 for 3RP15 05-1BT20							
Working range of excitation ¹⁾		0.85 to 1.1 x U _s for AC; 0.8 to 1.25 x U _s for DC 0.95 to 1.05 x rated frequency							
Rated power Power consumption at 230 V AC, 50 Hz	W VA	1 4	2 6	2 6	2 2 ²⁾	2 6	2 6	1 1	
Rated operational current I_e AC-15 at AC 230 V, 50 Hz AC-14; DC-13 DC-13 at 24 V DC-13 at 48 V DC-13 at 60 V DC-13 at 110 V DC-13 at 230 V	A	3 ³⁾ – 1 0.45 0.35 0.2 0.1						– 0.01 to 0.6 – – – – –	
Required DIAZED fuse ⁴⁾ Utilisation category	gL/gG A	4							
Operating frequency • when loaded with I _e AC 230 V • when loaded with 3RT10 16 contactor, AC 230 V	1/h 1/h	2500 5000						5000 5000	
Recovery time	ms	150 ⁵⁾				300	150	50	
Minimum ON period	ms	35	35 ⁶⁾	–	200 ⁷⁾	–			
Off-state current with non-conducting output	mA								≤ 5
Voltage drop with conducting output	V								≤ 3.5
Short-time loading capacity	A								10 (up to 10 ms)
Setting accuracy referred to upper limit of scale		typical ± 5 %							
Repeat accuracy		≤ v ± 1 %							
Mechanical endurance operating cycles		30 x 10 ⁶						100 x 10 ⁶	
Permissible ambient temperature in operation when stored	°C °C	–25 to +60 –40 to +85							
Degree of protection acc. to EN 60 529		cover IP 40 terminals IP 20							
Conductor cross-sections	Main conductors, auxiliary conductors								
• Screw connection (to connect 1 or 2 conductors for standard screwdriver size 2 and Pozidriv 2)	solid	mm ²	2 x (0.5 to 1.5) 2 x (0.75 to 4)	1 x (0.5 ... 4) 2 x (0.5 ... 2.5)					
	finely stranded with end sleeve	mm ²	2 x (0.5 to 2.5)	1 x (0.5 ... 2.5) 2 x (0.5 ... 1.5)					
	solid or stranded AWG conductors	AWG	2 x (18 to 14)	2 x (20 ... 14)					
	terminal screw		M 3	M 3.5					
	tightening torque	Nm		0.8 to 1.2					
• Cage Clamp connection (1 or 2 wire connection; for 22.5 mm time-delay relay use screwdriver with blade width 3 mm or 8WA2 803 opening tool)	solid	mm ²	2 x (0.25 to 2.5)	2 x (0.25 ... 1.5)					
	finely stranded • with end sleeve	mm ²	2 x (0.25 to 1)	2 x (0.25 ... 1)					
	• without end sleeve	mm ²	2 x (0.25 to 1.5)	2 x (0.25 ... 1.5)					
	solid or stranded AWG conductors	AWG	2 x (24 to 14)	2 x (24 ... 16)					

1) If nothing else is stated.

2) Maximum inrush current 1 A/100 ms.

3) For 3RP15 05-.R: NC contact → I_e = 1 A

4) Without any welds acc. to IEC 60 947-5-1.

5) With 3RP15 05-.BW30/ .AW30/ .RW30 and 3RP15 25-.BW30, 10 to 250 ms, voltage-dependent.

6) Minimum ON period with 3RP15 00-.BW30, 150 ms until instantaneous contact has switched.

7) For correct operation, observe minimum ON period.

Technical data acc. to IEC 61 812-1/DIN VDE 0435 Part 2021

Type	3RP20 05 3RP20 25	3RP15 05 3RP15 31 3RP15 32 3RP15 33	3RP15 11 3RP15 12 3RP15 13 3RP15 25 3RP15 55	3RP15 40	3RP15 60	3RP15 74 3RP15 76	3RP15 27
Permissible mounting position	any						
Shock resistance Half sine acc. to IEC 60 068-2-27	g/ms	15/11					
Vibration performance acc. to IEC 60 068-2-6	Hz/mm	10-55 / 0.35					
EMC tests acc. to basic specification	IEC 61 000-6-2 / EN 50 081-1						

Type	7PV33 48	7PV41 48	7PV43 48
Rated insulation voltage Overvoltage category C acc. to DIN VDE 0110	AC V	250	
Working range of excitation	+ 10 ... - 15 %	24 V: - 15 ... + 30 % 115/230 V: - 15 ... + 10 %	
Rated power Power consumption at AC 230 V, 50 Hz	W VA	1 11	
Rated operational current I_e AC-1 at AC 230 V, 50 Hz	A	8	
Operating frequency • when loaded with I_e , AC 230 V • when loaded with 3RT10 16 contactor, AC 230 V	1/h 1/h	600	
Recovery time	ms	50	100
Minimum ON period	ms	50	100
Setting accuracy with reference to upper limit of scale		± 0.03 %, ± 10 ms	± 10 %
Repeat accuracy		± 0.03 %, ± 10 ms	± 2 %
Mechanical endurance operating cycles		5 x 10 ⁶	2 x 10 ⁷
Permissible ambient temperature in operation when stored	°C °C	- 10 ... +60 - 30 ... +70	- 20 ... +60 - 25 ... +70
Degree of protection acc. to EN 60 529		IP 65	IP 50
Permissible mounting position		any	

3RP20/3RP15/7PV

Functions

Function table

Function	Function diagram	3RP20 time relays and 7PX9 coding plug	3RP15 time relays and 3RP15 19 label set									
		3RP20 05 7PX9 904	3RP20 25	3RP15 05--A 3RP19 01-0A	Code letter	3RP15 1.	3RP15 25	3RP15 27	3RP15 3.	3RP15 40	3RP15 55	3RP15 7.

1 changeover contact

ON-delay		■	■	■	A	■	■					
OFF-delay with auxiliary voltage		■		■	B ¹⁾				■			
OFF-delay without auxiliary voltage										■		
ON-delay and OFF-delay with auxiliary voltage ($t = t_{on} = t_{off}$)		■		■	C ¹⁾							
flashing, starting with interval (pulse/interval 1:1)		■		■	D							
clock-pulse, starting with interval (dead interval, pulse time and time setting ranges each separately adjustable)												■
passing make contact		■		■	E							
passing break contact with auxiliary voltage		■		■	F ¹⁾							
passing make contact and passing break contact												
pulse shaping with auxiliary voltage (pulse generation at the output does not depend on duration of energising)		■		■	G ¹⁾							
additive ON-delay with auxiliary voltage		■		■	H ¹⁾							

1 normally open contact (semiconductor)

ON-delay: The two-wire time relay is connected in series with the load. Timing begins after application of the exciting voltage. The semiconductor output then becomes conducting, and the load is energised.

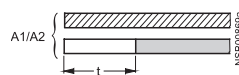

1) Note on function with start contact: Another control signal at terminal B after the operating time has started resets the operating time to zero. This does not apply to "G", "G•" and "H", "H•", that cannot be retrIGGERED.

Functions

Function table

Function	Function diagram	3RP20 time relays and 7PX9 coding plug	3RP15 time relays and 3RP19 label set											
		3RP20 05-B 7PX9 904	3RP20 25	3RP15 05-B 3RP19 01-0B	3RP15 05-R 3RP19 01-0A	Code letter	3RP15 1.	3RP15 25	3RP15 27	3RP15 3.	3RP15 40	3RP15 55	3RP15 60	3RP15 7.
ON-delay		■		■	■	A	■							
ON-delay and instantaneous contact		■		■		A●								
OFF-delay with auxiliary voltage		■		■	■	B 1)								
OFF-delay with auxiliary voltage and instantaneous contact		■		■		B● 1)								
OFF-delay without auxiliary voltage		■								■				
ON-delay and OFF-delay with auxiliary voltage ($t = t_{on} = t_{off}$)		■		■	■	C 1)								
ON-delay and OFF-delay with auxiliary voltage and instantaneous switching ($t = t_{on} = t_{off}$)		■		■		C● 1)								
flashing, starting with interval (pulse/interval 1:1)		■		■	■	D								
flashing, starting with interval (pulse/interval 1:1) and instantaneous contact		■		■		D●								
passing make contact		■		■	■	E								
passing make contact and instantaneous contact		■		■		E●								

1) Note on function with start contact: another control signal at terminal B after the operating time has started resets the operating time to zero. This does not apply to G, G● and H, H●, that cannot be retrigged.

3RP20/3RP15/7PV

Functions

Function table

Function	Function diagram	3RP20 time relays and 7PX9 coding plug	3RP15 time relays and 3RP19 label set											
		3RP20 05--B 7PX9 904	3RP20 25	3RP15 05--B 3RP19 01-0B	3RP15 05--R 3RP19 01-0A	Code letter	3RP15 1.	3RP15 25	3RP15 27	3RP15 3.	3RP15 40	3RP15 55	3RP15 60	3RP15 7.

2 changeover contacts

passing break contact with auxiliary voltage 	A1/A2 B1/A2 15/18 15/16 25/28 25/26 NSB00882	■	■	■	F ¹⁾								
passing break contact with auxiliary voltage and instantaneous contact 	A1/A2 B1/A2 15/18 15/16 21/24 21/22 NSB00883	■	■		F● ¹⁾								
pulse shaping with auxiliary voltage (pulse generation at the output does not depend on duration of energising) 	A1/A2 B1/A2 15/18 15/16 25/28 25/26 NSB00884	■	■	■	G ¹⁾								
pulse shaping with auxiliary voltage and instantaneous contact (pulse generation at the output does not depend on duration of energising) 	A1/A2 B1/A2 15/18 15/16 21/24 21/22 NSB00885	■	■		G● ¹⁾								
additive ON-delay with auxiliary voltage 	A1/A2 B1/A2 15/18 15/16 25/28 25/26 NSB00886			■	H ¹⁾								
additive ON-delay with auxiliary voltage and instantaneous contact 	A1/A2 B./A2 15/18 15/16 21/24 21/22 NSB01381	■	■		H● ¹⁾								
star-delta function 	A1/A2 17/18 27/28 NSB00888	■	■		YΔ								

2 normally open contacts

star-delta function YΔ 	A1/A2 17/18 17/28 NSB00889												■
----------------------------	-------------------------------------	--	--	--	--	--	--	--	--	--	--	--	---

3 normally open contacts

star delta function with overtravel function (idling) 	A1/A2 B1/A2 17/18 17/28 17/16 NSB00990												■
---	---	--	--	--	--	--	--	--	--	--	--	--	---

1) Note on function with start contact: another control signal at terminal B after the operating time has started resets the operating time to zero. This does not apply to G, G● and H, H●, that cannot be retriggered.

Overview

- Wide voltage range 12 ... 240 V AC/DC
- High switching capacity, e.g. AC15 at 230 V, 3 A
- Combination voltage, e.g. 24 V AC/DC and 200 ... 240 V AC
- Changes to the time setting range during operation
- Changes to the function in the de-energized state
- High level of functionality and a high repeat accuracy of timer settings
- Integrated surge suppressor
- Function charts printed on the side of the device for reliable device adjustment

7PV15 electronic timing relays in 17.5 mm enclosure

Function	Time setting range	Rated control voltage U_s	Contacts *	Order No.
Multifunction timing relays				
7 functions	0.05 sec–100 h	12–240 V AC/DC	1 CO	7PV1508-1AW30
ON delay timing relays				
ON delay	0.5 sec–10 sec	AC/DC 24 AC 100–127 V	1 CO	7PV1512-1AQ30
ON delay	0.5 sec–10 sec	AC/DC 24 AC 200–240 V	1 CO	7PV1512-1AP30
ON delay	5 sec–100 sec	AC/DC 24 AC 100–127 V	1 CO	7PV1513-1AQ30
ON delay	5 sec–100 sec	AC/DC 24 AC 200–240 V	1 CO	7PV1513-1AP30
ON delay	0.05 sec–100 h	12–240 V AC/DC	1 CO	7PV1518-1AW30
ON delay	0.05 sec–100 h	90-127V AC/DC	1 CO	7PV1518-1AJ30
ON delay	0.05 sec–100 h	180-240V AC/DC	1 CO	7PV1518-1AN30
OFF delay timing relays				
OFF delay with auxiliary voltage	0.05 sec–100 h	12–240 V AC/DC	1 CO	7PV1538-1AW30
OFF delay without auxiliary voltage	0.05 sec–100 sec	12–240 V AC/DC	1 CO	7PV1540-1AW30
Clock generator				
Clock generator	0.05 sec–100 h	12–240 V AC/DC	1 CO	7PV1558-1AW30
Star-delta timing relays				
Star-delta	0.05 sec–100 h	12–240 V AC/DC	2 CO	7PV1578-1BW30

* CO - changeover contact

Multifunction timing relays with 7 functions 7PV1508-1AW30

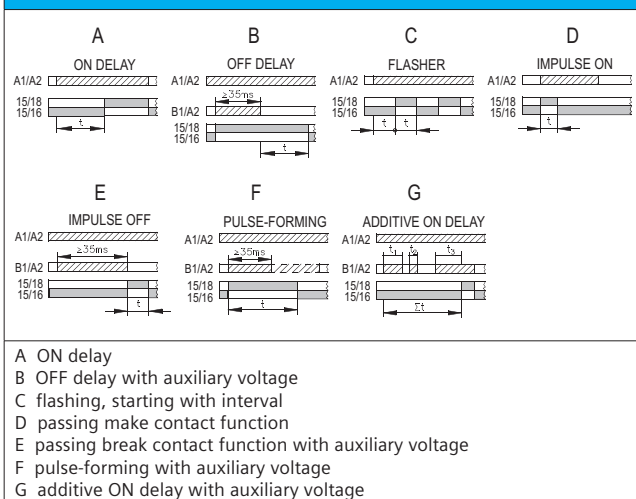

OFF delay without auxiliary voltage	Clock generator	Star-delta
7PV1540-1AW30	7PV1558-1AW30	7PV1578-1BW30

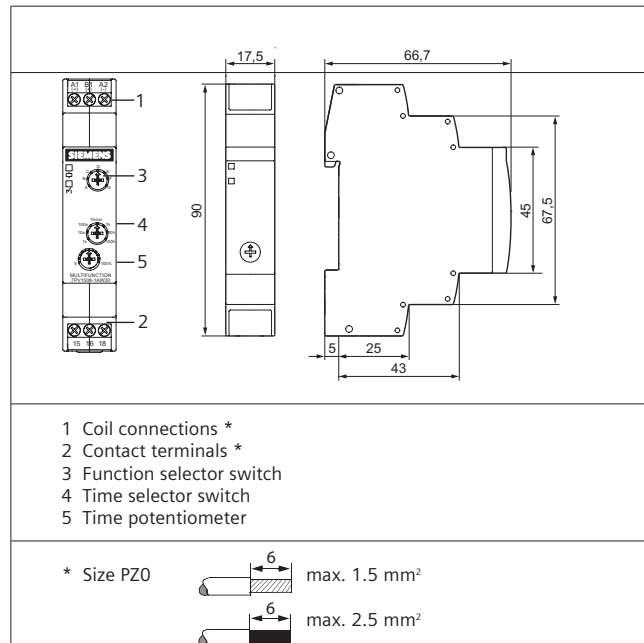

Circuit diagrams

Device circuit diagrams (terminal designations acc. to DIN 46 199, Part 5)

3RP20 05
3RP20 25
3RP15 05-.A
3RP151.
3RP15 25-.A

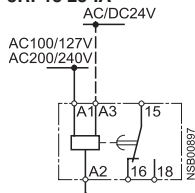

ON-delay

3RP20 05
3RP15 05-.A
3RP15 3-.A

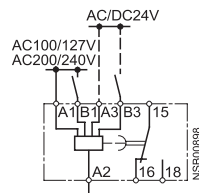

OFF-delay
with auxiliary voltage

3RP20 05
3RP15 05-.A

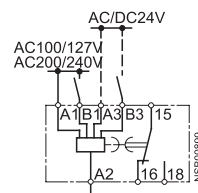

ON-delay and OFF-delay
with auxiliary voltage

3RP20 05
3RP15 05-.A

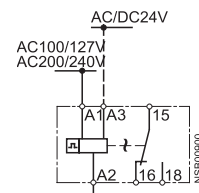

Flashing

3RP20 05
3RP15 05-.A

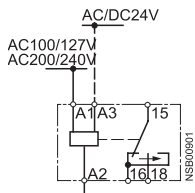

Passing make contact

3RP20 05
3RP15 05-.A

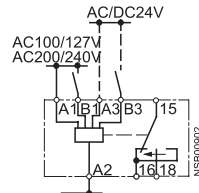

Passing break contact
with auxiliary voltage

3RP20 05
3RP15 05-.A

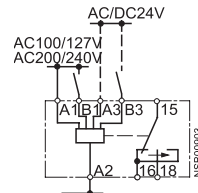

Pulse shaping
with auxiliary voltage

3RP15 05-.A

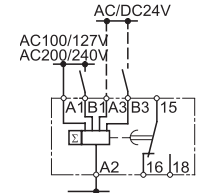

Additive ON-delay
with auxiliary voltage

3RP15 27

$U = \text{AC/DC } 24\text{--}66 \text{ V}$
 $\text{AC/DC } 90\text{--}240 \text{ V}$

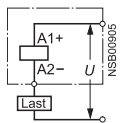

ON-delay,
two-wire version

3RP15 40-.A

AC/DC 24V
AC/DC 100/127V
AC/DC 200/240V

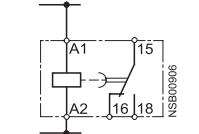

OFF-delay
without auxiliary voltage

3RP15 55

AC/DC 24V
AC/DC 42V...48V
AC/DC 60V
AC/DC 100/127V
AC/DC 200/240V

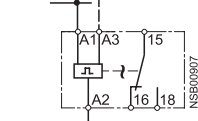

Clock-pulse relay

3RP15 05-.AW30

AC/DC 24...240V

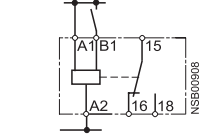

Multifunction relay
(functions as for 3RP15 05-1A)

3RP15 05-.B, 3RP15 25-1B

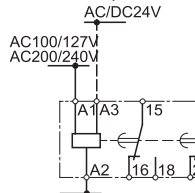

ON-delay, 3RP15 25-1B,
also for 42 to 48/60 V AC/DC
(see page 11/31 3RP15 25-1BR30)

3RP15 05-.B

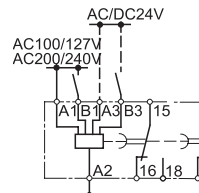

OFF-delay with auxiliary voltage

3RP15 05-.B

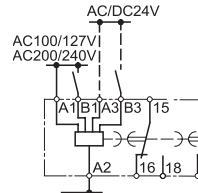

ON-delay and OFF-delay
with auxiliary voltage

3RP15 05-.B

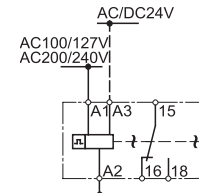

Flashing

3RP15 05-.B

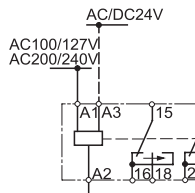

Passing make contact

3RP15 05-.B

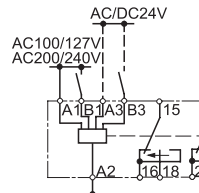

Passing break contact
with auxiliary voltage

3RP15 05-.B

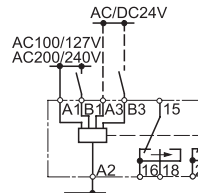

Pulse shaping with auxiliary voltage

3RP15 05-.B

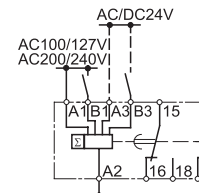

Additive ON-delay
with auxiliary voltage
and instantaneous contact

Circuit diagrams

Device circuit diagrams (terminal designations acc. to DIN 46 199, Part 5)

3RP15 05-B

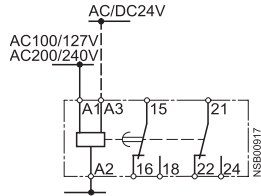

ON-delay and instantaneous contact

3RP15 05-B

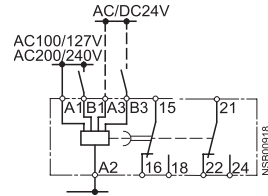

OFF-delay with auxiliary voltage and instantaneous contact

3RP15 05-B

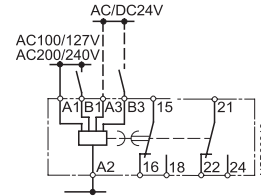

ON-delay and OFF-delay with auxiliary voltage and instantaneous contact

3RP15 05-B

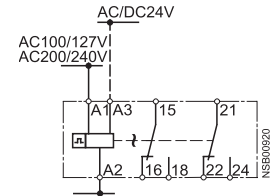

Flashing and instantaneous contact

3RP15 05-B

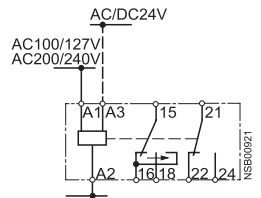

Passing make contact and instantaneous contact

3RP15 05-B

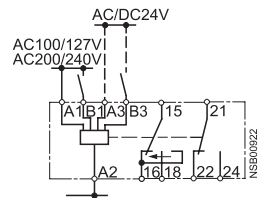

Passing break contact with auxiliary voltage and instantaneous contact

3RP15 05-B

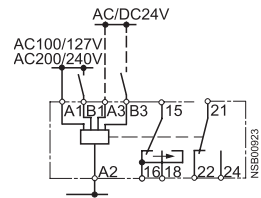

Pulse shaping with auxiliary voltage and instantaneous contact

3RP15 05-B

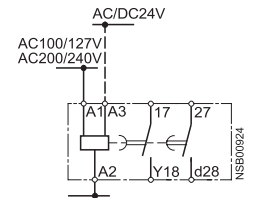

Star-delta function

3RP15 74, 3RP15 76

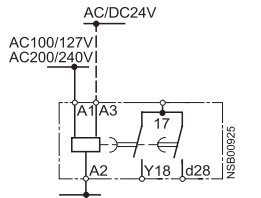

star delta time relay

3RP15 40-B

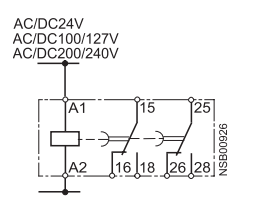

OFF-delay without auxiliary voltage

3RP15 05-BW30 / -1BT20 / -RW30 3R920 05-B

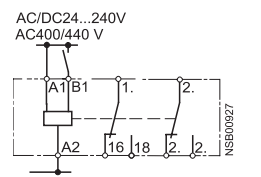

Multifunction relay (for functions see function table)

3RP15 25-BR30 3R920 05-B

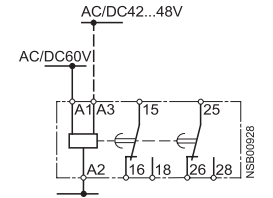

ON-delay

3RP15 25-BW30

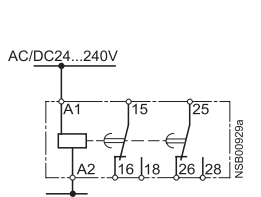

ON-delay

3RP15 60-S

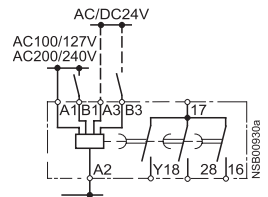

Star delta time relay with overtravel function (idling)

Function Relays, Interfaces and Converters

3UG Monitoring Relays

For line, single-phase voltage and insulation monitoring

SIRIUS
RELAYS

The new 3UG4 line monitoring relays permit a maximum degree of protection to be achieved for machines, plants and systems. This means that line and voltage faults can be detected early on and the appropriate response is initiated before far more significant subsequent damage can occur.

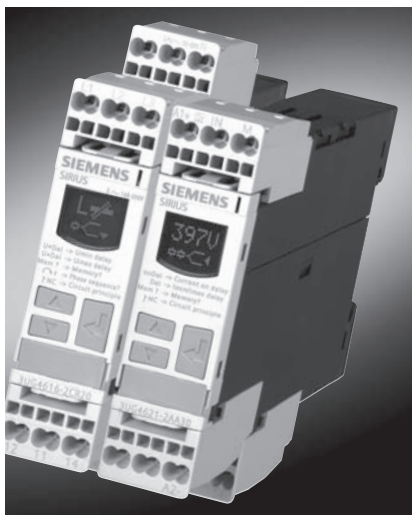

Your advantages:

- Thanks to the wide voltage range, it can be used on all line supplies around the world – from 160 V to 690 V – without an auxiliary voltage
- Can be variably set to above range, below range or window monitoring
- Freely parameterizable delay times and reset behavior
- Reduced width for all versions for line and voltage monitoring
- For the digital versions, the actual value and fault type are permanently displayed
- Automatic direction of rotation correction by differentiating between line faults and incorrect phase sequence
- All versions have removable terminals
- All versions have either screw terminals or alternatively innovative Cage Clamp terminals

Applications:

The applications are listed in the following table. These tables indicate the various plant system conditions that can be detected using the monitoring parameters.

Configuration of a 3-phase monitoring function

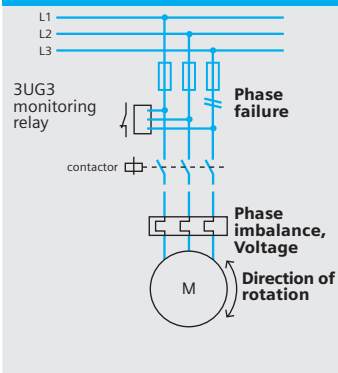

Measured quantity	Possible plant or system fault
Phase sequence	<ul style="list-style-type: none"> • Direction of rotation of the drive
Phase failure	<ul style="list-style-type: none"> • A fuse has blown • Control supply voltage has failed • Single-phase operation of a motor with the corresponding overheating
Phase dissymmetry	<ul style="list-style-type: none"> • Motor overheating as a result of non-symmetrical voltages or phase failure • Line supplies with non-symmetrical load are detected • A phase failure is detected in spite of regenerative feedback
Undervoltage	<ul style="list-style-type: none"> • Motor draws an increased current and in turn overheats • A device is undesirably reset • Line supply dips, especially when supplied from a battery • Threshold value switch for analog signals 0 to 10 V
Overvoltage	<ul style="list-style-type: none"> • A plant is protected against destruction due to supply overvoltages • A plant or system switches-in above a certain voltage • Threshold value switch for analog signals 0 to 10 V
Insulation monitoring	<ul style="list-style-type: none"> • The insulation resistance for non-grounded plants and systems is monitored

3UG4 Monitoring relays for the line supply and three-phase voltages

Phase sequence	Phase failure	Phase imbalance	Hysteresis	Under-voltage	Over-voltage	N-conductor monitoring	Delay time	Contacts	Line supply voltage	Order No.	List Price \$
22.5 mm wide 3UG4514 to 3UG3518 can be digitally set, with fault memory and with LCD display											
Yes	–	–	–	–	–	–	–	1 CO	160–260 320–500 420–690	3UG4511-□AN20 3UG4511-□AP20 3UG4511-□AQ20	
								2 CO	160–260 320–500 420–690	3UG4511-□BN20 3UG4511-□BP20 3UG4511-□BQ20	
Yes	Yes	10%	–	–	–	–	–	1 CO	160–690	3UG4512-□AR20	
								2 CO	160–690	3UG4512-□BR20	
Yes	Yes	20%	5%	160–690 V	–	–	Off delay 0–20 s	2 CO	160–690	3UG4513-□BR20	
Selectable	Yes	0–20%	1–20 V	160–690 V	–	–	On and off delay 0–20 s	2 CO	160–690	3UG4614-□BR20	
Selectable	Yes	Using threshold values	1–20 V	160–690 V	160–690 V	–	0–20 s for V_{min} and V_{max}	1 CO for V_{min} and V_{max}	160–690	3UG4615-□CR20	
Selectable	Yes	Using threshold values	1–20 V	160–690 V	160–690 V (90–400 w.r.t. N)	Yes	0–20 s for V_{min} and V_{max}	1 CO for V_{min} and V_{max}	160–690 (90–400 w.r.t. N)	3UG4616-□CR20	
Autom. correction	Yes	0–20%	1–20 V	160–690 V	160–690 V	–	Off delay 0–20 s	1 CO for line faults and 1 W for phase sequence	160–690	3UG4617-□CR20	
Autom. correction	Yes	0–20%	1–20 V	160–690 V	160–690 V (90–400 w.r.t. N)	Yes	Off delay 0–20 s	1 CO for line faults and 1 W for phase sequence	160–690 (90–400 w.r.t. N)	3UG4618-□CR20	

Screw Terminal 1

Spring-type Terminal 2

Return voltage due to coupling between the individual phases

Loads connected to the three-phase line supply – such as motor windings, lamps, transformers – result in a coupling between the individual phases.

As a result of this coupling, there is always a return voltage at the equipment terminal of the phase that has failed.

Single-phase voltage monitoring



Measuring range	Hysteresis	Contacts	Delay time	Auxiliary voltage	Order No.	List Price \$
22.5 mm wide, all of the devices can be digitally set and have an LCD display, a fault memory that can be switched-in, simultaneous monitoring for overvoltage and undervoltage over the complete measuring range						
17–275 V AC DC	0.1–150 V	1 CO	0–20 s	Selfsupplied	3UG4633-□AL30	
0.1–60 V AC DC	0.1–30 V	1 CO	0–20 s	24 V AC DC	3UG4631-□AA30	
				24–240 V AC DC	3UG4631-□AW30	
10–600 V AC DC	0.1–300 V	1 CO	0–20 s	24 V AC DC	3UG4632-□AA30	
				24–240 V AC DC	3UG4632-□AW30	

Screw Terminal 1

Spring-type Terminal 2

Line monitoring

Technical specifications

Type		3UG45 11- ..N20	3UG45 11- ..P20	3UG45 11- ..Q20	3UG45 12	3UG45 13	3UG46 14	3UG46 15 3UG46 17	3UG46 16 3UG46 18	
General data										
Rated control supply voltage U_s¹⁾	V	160 ... 260	320 ... 500	420 ... 690	160 ... 690				90 ... 400	
Rated frequency	Hz	50/60								
Rated power , typical										
• At AC 230 V	W/VA	2/4	--	--	2/2.5					
• At AC 400 V	W/VA	--	2/8	--	2/3.5					
• At AC 460 V	W/VA	--	--	2/8	2/4					
Width	mm	22.5								
RESET		Auto-RESET					Automatic/manual			
Principle of operation		Closed-circuit					Closed-circuit, open-circuit (3UG46 17/3UG46 18: closed-circuit)			
Availability time after application of U_s	ms	200			1.000					
Response time once a switching threshold is reached	ms	Max. 450								
Unbalance	%	--			10	20	0; 5 ... 20	3UG46 15/3UG46 16: Through threshold values 3UG46 17/3UG46 18: 0; 5 ... 20		
Adjustable tripping delay time	s	--				0.1 ... 20				
Adjustable ON-delay time	s	--						0.1 ... 20	--	
Mains buffering time , minimum	ms	10			30					
Rated insulation voltage U_i Degree of pollution 3 Overtoltage category III acc. to EN 60664-1	V	690								
Rated impulse withstand voltage	kV	6								
Permissible ambient temperature										
• During operation	°C	-25 ... +60								
• During storage	°C	-40 ... +85								
EMC tests²⁾		IEC 60947-1/IEC 61000-6-2/IEC 61000-6-4								
Degree of protection										
• Enclosure		IP40								
• Terminals		IP20								
Vibration resistance acc. to IEC 60068-2-6		1 ... 6 Hz: 15 mm; 6 ... 500 Hz: 2 g								
Shock resistance acc. to IEC 60068-2-27		12 shocks (half-sine 15 g/11 ms)								
Connection type		 Screw terminals								
• Terminal screw		M 3 (standard screwdriver, size 2 and Pozidriv 2)								
• Solid	mm ²	1 x (0.5 ... 4)/2 x (0.5 ... 2.5)								
• Finely stranded with end sleeve	mm ²	1 x (0.5 ... 2.5)/2 x (0.5 ... 1.5)								
• AWG cables, solid or stranded	AWG	2 x (20 ... 14)								
• Tightening torque	Nm	0.8 ... 1.2								
Connection type		 Spring-type terminals								
• Solid	mm ²	2 x (0.25 ... 1.5)								
• Finely stranded, with end sleeves acc. to DIN 46228	mm ²	2 x (0.25 ... 1.5)								
• Finely stranded	mm ²	2 x (0.25 ... 1.5)								
• AWG cables, solid or stranded	AWG	2 x (24 ... 16)								
Measuring circuit										
Measuring range AC 50/60 Hz rms value	V	160 ... 260	320 ... 500	420 ... 690	160 ... 690					
Setting range	V					200...690	160...690	90...400		
Measuring accuracy	%	--				±5				
Repeat accuracy At constant parameters	%	--				±1				
Setting accuracy		--				±10 % referred to setting		±1 V		
Accuracy of digital display		--				±1 digit				
Deviations for temperature fluctuations	%/°C	--				±0.1				
Hysteresis for voltage	V	--				5 % from setting		1 ... 20 V		
Hysteresis for unbalance	%	--						(setting - 2) 3UG46 17/3UG46 18: (setting - 2)		
Deviation for frequency fluctuation	%	--				±1				

¹⁾ Absolute limit values.

²⁾ Important: This is a Class A product. In the household environment this device may cause radio interference. In this case the user must introduce suitable measures.

	3UG45 11- ..N20	3UG45 11- ..P20	3UG45 11- ..Q20	3UG45 12	3UG45 13	3UG46 14	3UG46 15 3UG46 17	3UG46 16 3UG46 18
Control circuit								
Load capacity of the output relay • Conventional thermal current I_{th}	A	5						
Rated operational current I_e at • AC-15/24 ... 400 V • DC-13/24 V • DC-13/125 V • DC-13/250 V	A	3						
	A	1						
	A	0.2						
	A	0.1						
Minimum contact load at 17 V DC	mA	5						
Output relay with DIAZED fuse gL/gG operational class	A	4						
Electrical endurance AC-15	Million operating cycles	0.1						
Mechanical endurance	Million operating cycles	10						

Dimensional drawings

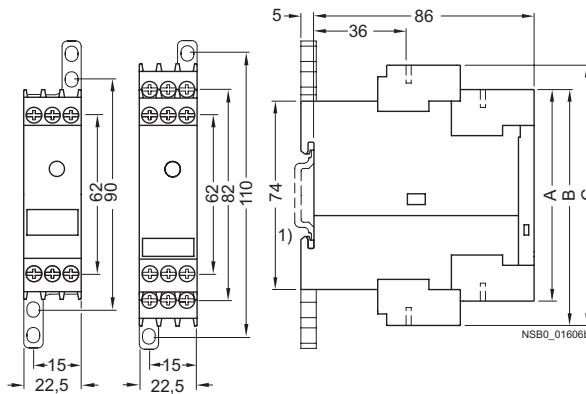

Type	3UG45 11-A 3UG45 12-A	3UG45 11-B 3UG45 12-B 3UG45 13 3UG46 14 3UG46 15 3UG46 17	3UG46 16 3UG46 18
	A	B	C

Removable terminal

Screw-type terminal	83	92	102
Spring-loaded terminal	84	94	103

1) For standard mounting rail according to EN 60715.

Schematics

3UG45 11-A
3UG45 12-A

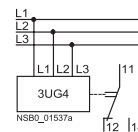

3UG45 11-B
3UG45 12-B
3UG45 13
3UG46 14
3UG46 15
3UG46 17

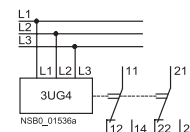

3UG46 16
3UG46 18

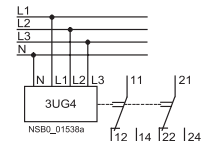

Note: It is not necessary to protect the measuring circuit for device protection. The protective device for line protection depends on the cross-section used.

Position of the terminals

3UG45 11-A
3UG45 12-A

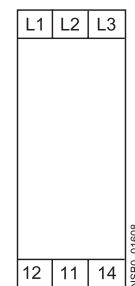

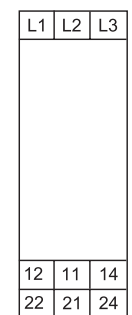

3UG45 11-B
3UG45 12-B
3UG45 13
3UG46 14
3UG46 15
3UG46 17

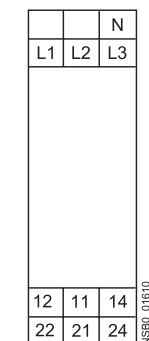

3UG46 16
3UG46 18



Technical specifications

		3UG46 31- .AA	3UG46 31- .AW	3UG46 32- .AA	3UG46 32- .AW	3UG46 33
General data						
Rated control supply voltage U_s	V	24 AC/DC	24...240 AC/DC	24 AC/DC	24...240 AC/DC	17 ... 275 ¹⁾ AC/DC
Rated frequency for AC	Hz	50/60				40 ... 500
Operating range	V	20.4 ... 27.6	20.4 ... 264	20.4 ... 27.6	20.4 ... 264	17...275
Rated power in W/VA	VA	2/4				
Width	mm	22.5				
RESET		Automatic/manual				
Availability time after application of U_s	ms	1000				
Response time once a switching threshold is reached	ms	Max. 450				
Adjustable tripping delay time	s	0.1 ... 20				
Adjustable ON-delay time	s	--				0.1 ... 20
Mains buffering time, minimum	ms	10				
Rated insulation voltage U_i Degree of pollution 3 Overvoltage category III acc. to EN 60664-1	V	690				
Rated impulse withstand voltage U_{imp}	kV	6				
Protective separation acc. to EN 60947-1, Annex N	V	300				
Permissible ambient temperature	°C	-25 ... +60				
• During operation	°C	-40 ... +85				
• During storage						
EMC tests ²⁾		IEC 60947-1/IEC 61000-6-2/IEC 61000-6-4				
Degree of protection		IP40 IP20				
• Enclosure						
• Terminals						
Vibration resistance acc. to IEC 60068-2-6		1 ... 6 Hz: 15 mm; 6 ... 500 Hz: 2 g				
Shock resistance acc. to IEC 60068-2-27		12 shocks (half-sine 15 g/11 ms)				
Connection type		 Screw terminals				
• Terminal screw		M 3 (standard screwdriver, size 2 and Pozidriv 2)				
• Solid	mm ²	1 x (0.5 ... 4)/2 x (0.5 ... 2.5)				
• Finely stranded with end sleeve	mm ²	1 x (0.5 ... 2.5)/2 x (0.5 ... 1.5)				
• AWG cables, solid or stranded	AWG	2 x (20 ... 14)				
• Tightening torque	Nm	0.8 ... 1.2				
Connection type		 Spring-type terminals				
• Solid	mm ²	2 x (0.25 ... 1.5)				
• Finely stranded, with end sleeves acc. to DIN 46228	mm ²	2 x (0.25 ... 1.5)				
• Finely stranded	mm ²	2 x (0.25 ... 1.5)				
• AWG cables, solid or stranded	AWG	2 x (24 ... 16)				
Measuring circuit						
Permissible measuring range single-phase AC/DC voltage	V	0.1 ... 68		10 ... 650		17 ... 275
Setting range single-phase voltage	V	0.1 ... 60		10 ... 600		17 ... 275
Measuring frequency	Hz	40 ... 500				40 ... 500
Measuring accuracy	%	5				
Repeat accuracy at constant parameters	%	1				
Accuracy of digital display		±1 digit				
Deviations for temperature fluctuations	%/°C	±0.1				
Hysteresis for single-phase voltage	V	0.1 ... 30		0.1 ... 300		0.1 ... 150
Control circuit						
Load capacity of the output relay						
• Conventional thermal current I_{th}	A	5				
Rated operational current I_e at						
• AC-15/24 ... 400 V	A	3				
• DC-13/24 V	A	1				
• DC-13/125 V	A	0.2				
• DC-13/250 V	A	0.1				
Minimum contact load at 17 V DC	mA	5				
Output relay with DIAZED fuse gL/gG operational class	A	4				
Electrical endurance AC15	Million operating cycles	0.1				
Endurance with contactor relay	Million operating cycles	10				

¹⁾ Absolute limit values.

²⁾ Important: This is a Class A product. In the household environment this device may cause radio interference. In this case the user must introduce suitable measures.

Dimensional drawings

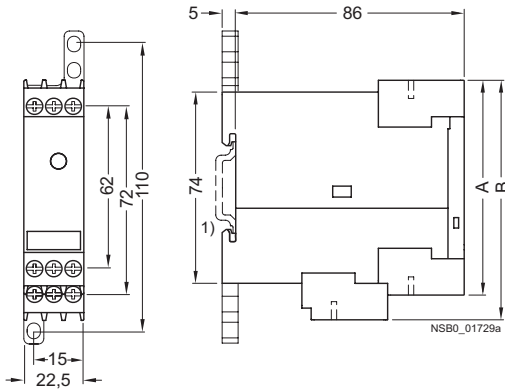

Type	3UG46 31	
	3UG46 32	
	3UG46 33	
	A	B

Removable terminal

Screw-type terminal	83	92
Spring-loaded terminal	84	94

1) For standard mounting rail according to EN 60715.

Schematics

3UG46 31-AA30
3UG46 32-AA30

3UG46 31-AW30
3UG46 32-AW30

3UG46 33

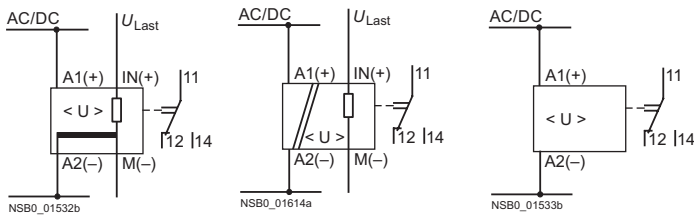

Note: It is not necessary to protect the measuring circuit for device protection. The protective device for line protection depends on the cross-section used.

Position of the terminals

3UG46 31
3UG46 32

3UG46 33

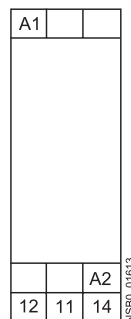
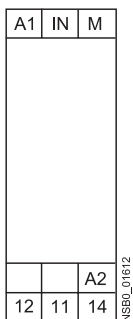

Function Relays, Interfaces and Converters

3UG Monitoring Relays

For single-phase current and $\cos \phi$ monitoring

SIRIUS RELAYS

Monitoring the load of motors and the functionality of electronic loads – a clear case for our 3UG relays that monitor current and $\cos \phi$. These devices detect the effect of wear and faults early on. This means that the appropriate actions can be taken before far more significant damage can occur.



Your advantages:

- 22.5 mm wide
- Can be digitally set and with LCD display
- Fault memory that can be switched-in
- Simultaneous monitoring for current overrange/underrange over the complete measuring range

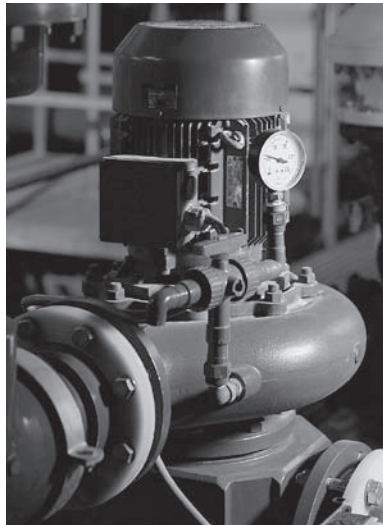

Current monitoring:

- Wide-voltage versions reduce stock inventory costs
- Only two versions from 2 mA to 10 A
- Can be variably set to overrange, underrange or window monitoring
- Freely parameterizable delay times and reset switch
- Actual value and fault type are permanently displayed
- All of the versions have removable terminals
- All of the versions have screw terminals or, alternatively, innovative Cage Clamp terminals

$\cos \phi$ monitoring:

- $\cos \phi$ is monitored for overrange and underrange
- Fault memory that can be switched-in
- Selectable starting bypass and delay time for threshold value out of range

Applications:

The applications can be seen in the adjacent table. These tables show the various plant/system states can be detected using the monitoring parameters.

For single-phase current and $\cos \varphi$ monitoring



3UG4 Monitoring relays – single-phase current monitoring

Measuring range	Hysteresis	Contacts	Starting-bypass time	Off delay	Auxiliary voltage	Order No.	List Price \$
22.5 mm wide, all of the devices can be digitally set and have an LCD display, a fault memory that can be switched-in, simultaneous monitoring for overcurrent and undercurrent over the complete measuring range							
2.0 mA AC/DC up to 500 mA AC/DC	0.1 mA–250 mA	1 CO	0–20 s	0–20 s	24 V AC/DC	3UG4621-□AA30	
					24–240 V AC/DC	3UG4621-□AW30	
0.05 A AC/DC up to 10 A AC/DC	0.01 A–5 A	1 CO	0–20 s	0–20 s	24 V AC/DC	3UG4622-□AA30	
					24–240 V AC/DC	3UG4622-□AW30	

Screw Terminal 1

Spring-type Terminal 2

Power factor and active current monitoring

Measuring range for power factor	Measuring range for active current I_{res}	Power factor hysteresis	Active current hysteresis	On delay	Tripping delay	Rated control supply voltage $V_s^{1)}$	Order No.	List Price \$
22.5 mm wide, all of the devices can be digitally set and have an LCD display, a fault memory that can be switched-in, simultaneous power factor and active current monitoring over the entire measuring range								
0.1–0.99 ($\cos \varphi$)	0.2–10.0 A	0.1 ($\cos \varphi$)	0.1–2.0 A	0–99 s	0.1–20.0 s	90–690 V AC	3UG4641-□CS20	

¹⁾ Absolute limits.

Screw Terminal 1

Spring-type Terminal 2

Monitoring parameter	Plant system states
Current monitoring	<ul style="list-style-type: none"> • Overload monitoring • Underload monitoring close to the rated torque • Monitoring the functionality of electric loads • Wire breakage monitoring • Energy management (phase current monitoring) • Threshold value switch for analog signals up to 20 mA
Power factor and active current monitoring	<ul style="list-style-type: none"> • No-load monitoring • Underload monitoring in the lower power range • Extremely simple power factor monitoring of line supplies to control compensation equipment • Energy management • Interrupted cable between the cabinet and the motor

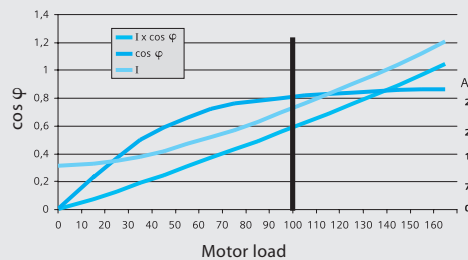

Current and $\cos \varphi$ as a function of the motor load

Rule of thumb:
 $\cos \varphi$ changes significantly below the rated load; the current increases overproportionally above the rated load.



The active current I_{res} indicates a linear correlation between the motor load and the measured value over the entire measuring range.

Technical specifications

		3UG46 21-AA	3UG46 21-AW	3UG46 22-AA	3UG46 22-AW
General data					
Rated control supply voltage U_s	V	24	24 ... 240	24	24 ... 240
Rated frequency	Hz	50/60			
Operating range	V	20.4 ... 26.4	20.4 ... 264	20.4 ... 26.4	20.4 ... 264
Rated power	W/VA	2/4			
Width	mm	22.5			
RESET		Automatic/manual			
Availability time after application of U_s	ms	1000			
Response time once a switching threshold is reached	ms	Max. 450			
Adjustable tripping delay time/ON-delay time	s	0.1 ... 20			
Mains buffering time, minimum	ms	10			
Rated insulation voltage U_i Degree of pollution 3; overvoltage category III acc. to EN 60664-1	V	690			
Rated impulse withstand voltage U_{imp}	kV	6			
Protective separation acc. to EN 60947-1, Annex N	V	300			
Permissible ambient temperature • During operation • During storage	°C	-25 ... +60 -40 ... +85			
EMC tests ¹⁾		IEC 60947-1/IEC 61000-6-2/IEC 61000-6-4			
Degree of protection • Enclosure • Terminals		IP40 IP20			
Vibration resistance acc. to IEC 60068-2-6		1 ... 6 Hz: 15 mm; 6 ... 500 Hz: 2 g			
Shock resistance acc. to IEC 60068-2-27		12 shocks (half-sine 15 g/11 ms)			
Connection type		 Screw terminals			
• Terminal screw • Solid • Finely stranded with end sleeve • AWG cables, solid or stranded • Tightening torque	mm ² mm ² AWG Nm	M 3 (standard screwdriver, size 2 and Pozidriv 2) 1 x (0.5 ... 4)/2 x (0.5 ... 2.5) 1 x (0.5 ... 2.5)/2 x (0.5 ... 1.5) 2 x (20 ... 14) 0.8 ... 1.2			
Connection type		 Spring-type terminals			
• Solid • Finely stranded, with end sleeves acc. to DIN 46228 • Finely stranded • AWG cables, solid or stranded	mm ² mm ² mm ² AWG	2 x (0.25 ... 1.5) 2 x (0.25 ... 1.5) 2 x (0.25 ... 1.5) 2 x (24 ... 16)			
Measuring circuit					
Measuring range for single-phase AC/DC current	A	0.003 ... 0.6		0.05 ... 15	
Setting range for single-phase current	A	0.003 ... 0.5		0.05 ... 10	
Load supply voltage	V	24	Max. 300 ²⁾ Max. 500 ³⁾	24	Max. 300 ²⁾ Max. 500 ³⁾
Measuring accuracy	%	5			
Repeat accuracy at constant parameters	%	1			
Accuracy of digital display		±1 digit			
Deviations for temperature fluctuations	%/°C	±0.1			
Hysteresis for single-phase current		0.1 ... 250 mA		0.01 ... 5 A	
Permissible overcurrent, continuous	A	0.6		15	
Permissible overcurrent, < 1 s	A	5		50	
Protection against destruction, DIAZED gL/gG	A	2		16	
Measuring circuit internal resistance, shunt	mΩ	500		5	
Control circuit					
Load capacity of the output relay • Conventional thermal current I_{th}	A	5			
Rated operational current I_o at • AC-15/24 ... 400 V • DC-13/24 V • DC-13/125 V • DC-13/250 V	A	3 1 0.2 0.1			
Minimum contact load at 17 V DC	mA	5			
Output relay with DIAZED fuse gL/gG	A	4			
Electrical endurance AC15 (million operating cycles)		0.1			
Endurance with contactor relay (million operating cycles)		10			

¹⁾ Important: This is a Class A product. In the household environment this device may cause radio interference. In this case the user must introduce suitable measures.

²⁾ With protective separation.

³⁾ With simple separation.

SIRIUS RELAYS

Current monitoring

1

2

3

4

5

6

7

8

9

10

11

Dimensional drawings

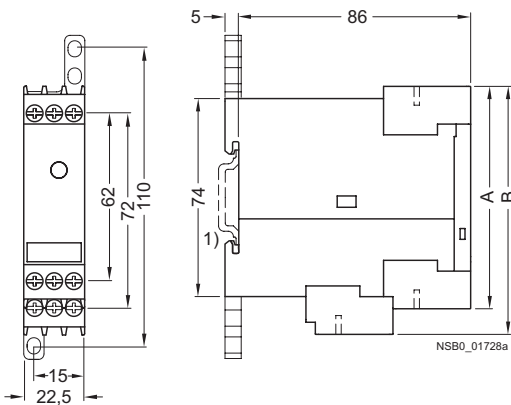

Type	3UG46 21	3UG46 22
	A	B

Removable terminal

Screw-type terminal	83	92
Spring-loaded terminal	84	94

1) For standard mounting rail according to EN 60715.

Position of the terminals

3UG46 21
3UG46 22

A1	IN	M
12	11	14
	A2	

NSB0_01611

Wiring diagram for 24 V AC/DC (only 3UG46 21-..AA30)

From the following circuit diagrams it is clear that loads in measuring circuits have to be in the current flow upstream from the monitoring relay. Otherwise, the monitoring relay could be destroyed and the short-circuit current could cause damage to the plant.

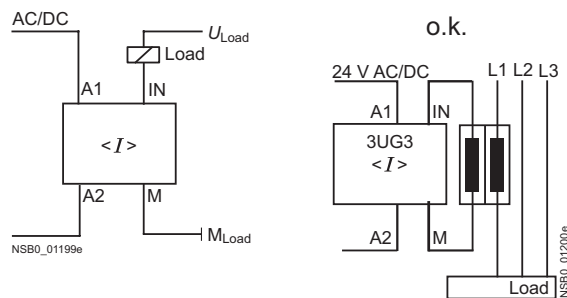

Schematics

3UG46 21-..AA30
3UG46 22-..AA30

Operation with separate control circuit and load circuit

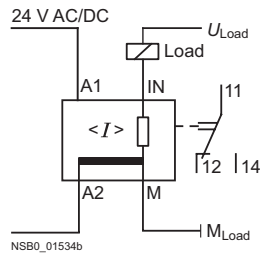

Operation with joint control circuit and load circuit

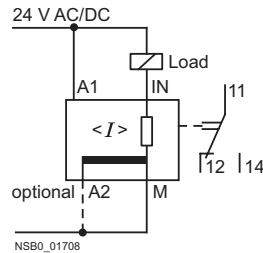

3UG46 21-..AW30
3UG46 22-..AW30

Single-phase operation

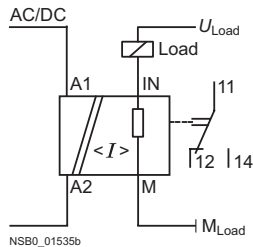

3-phase operation

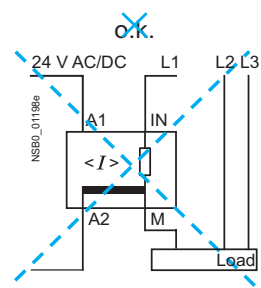
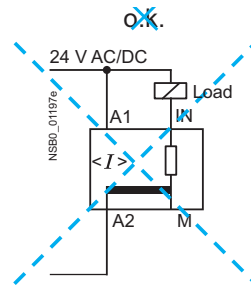
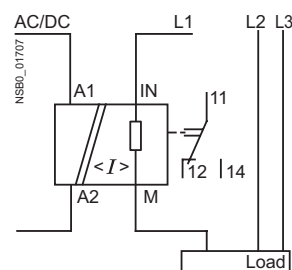



Configuring note:

A2 and M are electrically connected internally!

For applications in which the load to be monitored and the monitoring relay are supplied from the same power supply, there is no need for connection A2!

The load current must always flow through M or the monitoring relay may be destroyed!

Technical specifications

Type	3UG46 41	
General data		
Rated control supply voltage U_s	V	90 ... 690
Rated frequency	Hz	50/60
Rated power, typical		
• At 200 V AC	VA	2.0
• At 400 V AC	VA	2.7
• At 460 V AC	VA	3.1
Width	mm	22.5
RESET		Automatic/manual
Principle of operation		Closed-circuit principle, open-circuit principle
Availability time after application of U_s	ms	1000
Response time once a switching threshold is reached	ms	Max. 450
Adjustable tripping delay time	s	0.1 ... 20
Adjustable ON-delay time	s	0 ... 99
Mains buffering time, minimum	ms	10
Rated insulation voltage U_i	V	690
Degree of pollution 3 Overvoltage category III acc. to EN 60664-1		
Rated impulse withstand voltage	kV	6
Permissible ambient temperature		
• During operation	°C	-25 ... +60
• During storage	°C	-40 ... +85
EMC tests ¹⁾		IEC 60947-1/IEC 61000-6-2/IEC 61000-6-4
Degree of protection		
• Enclosure		IP40
• Terminals		IP20
Vibration resistance acc. to IEC 60068-2-6		1 ... 6 Hz: 15 mm; 6 ... 500 Hz: 2 g
Shock resistance acc. to IEC 60068-2-27		12 shocks (half-sine 15 g/11 ms)
Connection type		 Screw terminals
• Terminal screw		M 3 (standard screwdriver, size 2 and Pozidriv 2)
• Solid	mm ²	1 x (0.5 ... 4)/2 x (0.5 ... 2.5)
• Finely stranded with end sleeve	mm ²	1 x (0.5 ... 2.5)/2 x (0.5 ... 1.5)
• AWG cables, solid or stranded	AWG	2 x (20 ... 14)
• Tightening torque	Nm	0.8 ... 1.2
Connection type		 Spring-type terminals
• Solid	mm ²	2 x (0.25 ... 1.5)
• Finely stranded, with end sleeves acc. to DIN 46228	mm ²	2 x (0.25 ... 1.5)
• Finely stranded	mm ²	2 x (0.25 ... 1.5)
• AWG cables, solid or stranded	AWG	2 x (24 ... 16)
Measuring circuit		
Measurable active current I_{res}	A	0.2 ... 10
Max. permissible load current	A	10
Peak current < 1 s	A	50
Adjustable response value		0.1 ... 0.99
Phase displacement angle		
DI AZED protection, gL/gG operational class	A	16
Measuring accuracy	%	10
Repeat accuracy at constant parameters	%	1
Accuracy of digital display		± 1 digit
Deviations for temperature fluctuations	%/°C	±0.1
Hysteresis		0.10
Phase angle		
Hysteresis	A	0.1 ... 2.0
Active current monitoring		

¹⁾ Important: This is a Class A product. In the household environment this device may cause radio interference. In this case the user must introduce suitable measures.

Type	3UG46 41	
Control circuit		
Number of CO contacts for auxiliary contacts	2	
Load capacity of the output relay	A	
• Conventional thermal current I_{th}	A	5
Rated operational current I_e at	A	
• AC-15/24 ... 400 V	A	3
• DC-13/24 V	A	1
• DC-13/125 V	A	0.2
• DC-13/250 V	A	0.1
Minimum contact load at 17 V DC	mA	5
Output relay with DIAZED fuse	A	4
gL/gG operational class		
Electrical endurance AC-15	Million operating cycles	0.1
Mechanical endurance	Million operating cycles	10

Dimensional drawings

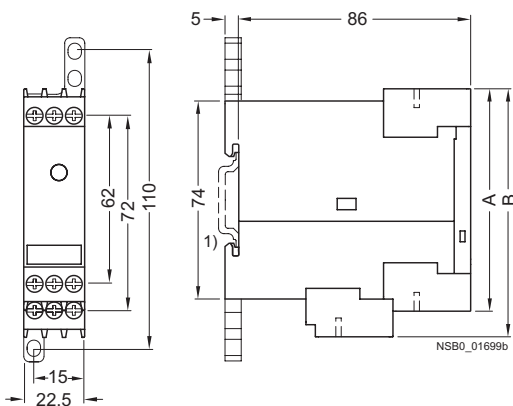

Type	3UG46 41	
	A	B

Removable terminal

Screw-type terminal	83	92
Spring-loaded terminal	84	94

1) For standard mounting rail according to EN 60715.

Schematics

Single-phase motors

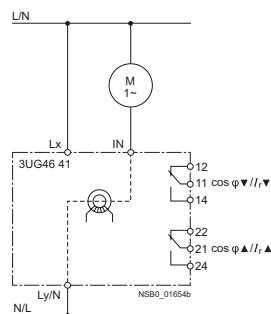

3-phase motors

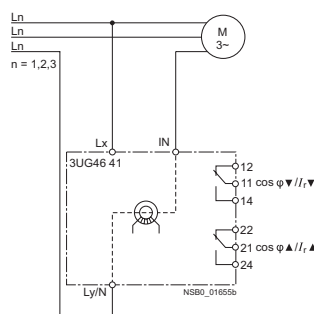

3-phase motors with transformers for currents > 10 A

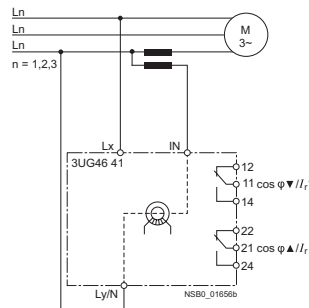

Legend

$\cos \varphi$: p. f.

Position of the terminals

3UG46 41

Lx	Ly/N	IN
12	11	14
22	21	24

NSB0_01657

Residual current monitoring: Residual-current monitoring relays

Overview

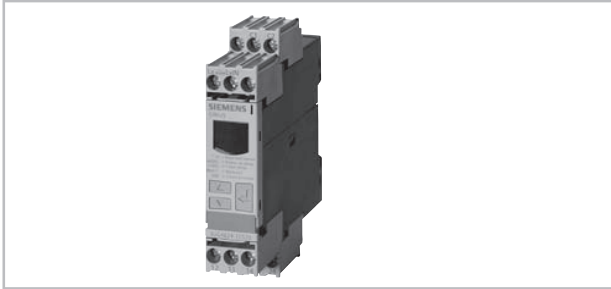

The 3UG46 24 residual current monitoring relay is used together with the 3UL22 summation current transformer for plant monitoring.

Application

- Plant monitoring

Selection and ordering data

- Relay for monitoring residual currents $I_{\Delta n}$ 0.3 ... 40 A
- For 3UL22 summation current transformers with feed-through opening 40 ... 120 mm
- Digital adjustable, with illuminated LCD
- Separately adjustable limit value and warning threshold
- Permanent display of actual value and tripping state
- 1 CO contact each for limit violation and warning threshold
- All terminals are removable
- Width 22.5 mm

Display range	Setting range	Hysteresis		ON/tripping delay time	Rated control supply voltage $U_s^{2)}$	Screw terminals		PU (UNIT, SET, M)	PS*	Weight per PU approx.
		Limit value	Warning value			Order No.	List Price \$ per PU			
A	A	A	A	s	V					kg
10 ... 120% of $I_{\Delta n}$	10 ... 100% of $I_{\Delta n}$	LSB ¹⁾ up to 50% of $I_{\Delta n}$	5% of $I_{\Delta n}$	0.1 ... 20	90 ... 690	3UG46 24-1CS20		1	1 unit	0.147

Display range	Setting range	Hysteresis		ON/tripping delay time	Rated control supply voltage $U_s^{2)}$	Spring-type terminals		PU (UNIT, SET, M)	PS*	Weight per PU approx.
		Limit value	Warning value			Order No.	List Price \$ per PU			
A	A	A	A	s	V					kg
10 ... 120% of $I_{\Delta n}$	10 ... 100% of $I_{\Delta n}$	LSB ¹⁾ up to 50% of $I_{\Delta n}$	5% of $I_{\Delta n}$	0.1 ... 20	90 ... 690	3UG46 24-2CS20		1	1 unit	0.130

¹⁾ LSB: Smallest adjustable value, transformer-dependent, $\leq 1\%$ of $I_{\Delta n}$.

²⁾ Absolute limit values.



Selection and ordering data

Feed-through opening diameter	Rated insulation voltage U_l	Rated fault current $I_{\Delta n}$	Screw terminals		PU (UNIT, SET, M)	PS*	Weight per PU approx.
mm	V	A	Order No.	List Price \$ per PU			kg

Summation current transformers (essential accessory for 3UG46 24 or SIMOCODE 3UF)

<p>3UL22</p>	40	690	0.3	3UL22 01-1A	1	1 unit	0.571
			0.5	3UL22 01-2A	1	1 unit	0.408
			1	3UL22 01-3A	1	1 unit	0.324
	65	690	0.3	3UL22 02-1A	1	1 unit	0.900
			0.5	3UL22 02-2A	1	1 unit	0.713
			1	3UL22 02-3A	1	1 unit	0.568
			6	3UL22 02-1B	1	1 unit	0.561
			10	3UL22 02-2B	1	1 unit	0.563
			16	3UL22 02-3B	1	1 unit	0.573
			25	3UL22 02-4B	1	1 unit	0.575
40	3UL22 02-5B	1	1 unit	0.564			
120	1000	0.3	3UL22 03-1A	1	1 unit	3.435	
		0.5	3UL22 03-2A	1	1 unit	2.810	
		1	3UL22 03-3A	1	1 unit	1.965	
		6	3UL22 03-1B	1	1 unit	1.955	
		10	3UL22 03-2B	1	1 unit	1.990	
		16	3UL22 03-3B	1	1 unit	1.917	
		25	3UL22 03-4B	1	1 unit	1.851	
		40	3UL22 03-5B	1	1 unit	1.905	

Technical specifications

Type	3UG46 24	
General data		
Rated control supply voltage U_s	V	90 ... 690 ¹⁾
Rated frequency	Hz	50/60
Rated power, typical		
• At 90 V AC	VA	2.8
• At 230 V AC	VA	2.4
• At 400 V AC	VA	3.1
• At 460 V AC	VA	3.2
• At 690 V AC	VA	4.7
Width	mm	22.5
RESET		Automatic/manual
Principle of operation		Closed-circuit principle, open-circuit principle
Availability time after application of U_s	ms	1000
Response time once a switching threshold is reached	ms	Max. 300
Adjustable delay time	s	0.1... 20
Mains buffering time, minimum	ms	10
Rated insulation voltage U_i	V	690
Degree of pollution 3 Overvoltage category III acc. to EN 60664-1		
Rated impulse withstand voltage	kV	6
Permissible ambient temperature		
• During operation	°C	-25 ... +60
• During storage	°C	-40 ... +85
EMC tests ²⁾		IEC 60947-1/IEC 61000-6-2/IEC 61000-6-4
Degree of protection		
• Enclosure		IP40
• Terminals		IP20
Vibration resistance acc. to IEC 60068-2-6		1 ... 6 Hz: 15 mm; 6 ... 500 Hz: 2 g
Shock resistance acc. to IEC 60068-2-27		12 shocks (half-sine 15 g/11 ms)
Connection type		 Screw terminals
• Terminal screw		M3 (for standard screw driver size 2 and Pozidriv 2)
• Solid	mm ²	1 x (0.5 ... 4)/2 x (0.5 ... 2.5)
• Finely stranded with end sleeve	mm ²	1 x (0.5 ... 2.5)/2 x (0.5 ... 1.5)
• AWG cables, solid or stranded	AWG	2 x (20 ... 14)
• Tightening torque	NM	0.8 ... 1.2
Connection type		 Spring-type terminals
• Solid	mm ²	2 x (0.25 ... 1.5)
• Finely stranded, with end sleeves acc. to DIN 46228	mm ²	2 x (0.25 ... 1.5)
• Finely stranded	mm ²	2 x (0.25 ... 1.5)
• AWG cables, solid or stranded	AWG	2 x (24 ... 16)
Measuring circuit		
Measurable residual current I_{res}	A	10 ... 120 % $I_{\Delta n}$ ($I_{\Delta n}$: rated residual current of the transformer)
Adjustable response value		
• Residual current		10 ... 100 % $I_{\Delta n}$
• Warning		10 ... 100 % $I_{\Delta n}$
Measuring accuracy	%	±5
Repeat accuracy at constant parameters	%	±1
Accuracy of digital display		± 1 digit
Deviations for temperature changes	%/°C	±0.1
Hysteresis for residual current		LSB ³⁾ up to 50 % $I_{\Delta n}$
Hysteresis for warning threshold	A	5 % $I_{\Delta n}$

1) Absolute limit values.

2) Important: This is a Class A product. In the household environment this device may cause radio interference. In this case the user must take suitable precautions.

3) LSB: Smallest adjustable value, transformer-dependent, ≤ 1 % of $I_{\Delta n}$.

Residual current monitoring: Residual-current monitoring relays

Type	3UG46 24	
Control circuit		
Number of CO contacts for auxiliary contacts	2	
Load capacity of the output relay		
Conventional thermal current I_{th}	A	5
Rated operational current I_e at		
• AC-15/24 ... 400 V	A	3
• DC-13/24 V	A	1
• DC-13/125 V	A	0.2
• DC-13/250 V	A	0.1
Minimum contact load at 17 V DC	mA	5
Output relay with DIAZED fuse	A	4
gL/gG operational class		
Electrical endurance AC-15	Million operating cycles	0.1
Mechanical endurance	Million operating cycles	10

Dimensional drawings

3UG46 24

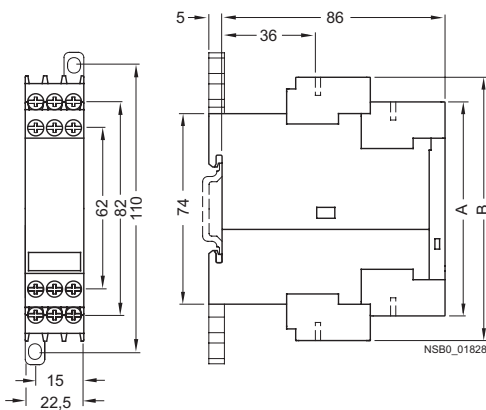

Type	3UG46 24	
	A	B

Removable terminal

Screw-type terminal	83	102
Spring-loaded terminal	84	103

1) For standard mounting rail according to EN 60715.

Circuit example

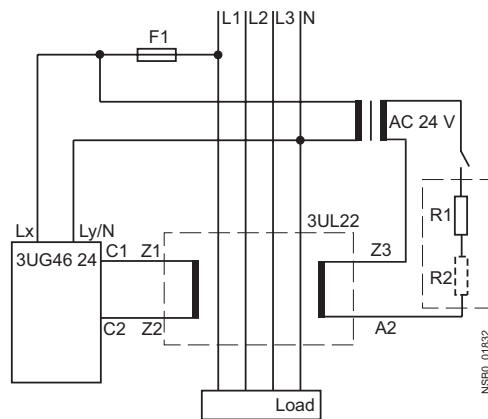

Type	$I_{\Delta n}$	R1	R2
3UL22 0.-1A	0,3 A	220Ω ≥ 3 W	--
3UL22 0.-2A	0,5 A		
3UL22 0.-3A	1 A		
3UL22 0.-1B	6 A	22 Ω ≥ 6 W	22 Ω ≥ 6 W
3UL22 0.-2B	10 A		
3UL22 0.-3B	16 A		
3UL22 0.-4B	25 A		
3UL22 0.-5B	40 A		

Position of the terminals

	C1	C2
Lx	Ly/N	
12	11	14
22	21	24

NSB0_01825

Schematics

3UG46 24

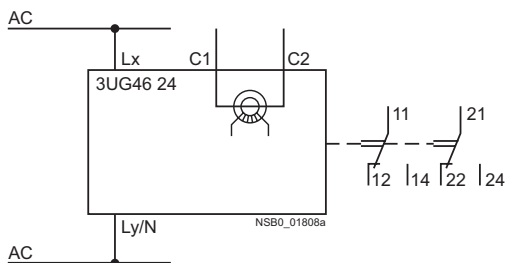

Note: It is not necessary to protect the measuring circuit for device protection. The protective device for line protection depends on the cross-section used.

Overview



SIRIUS 3UG45 8. insulation monitor

Insulation monitoring relays are used for monitoring the insulation resistance between ungrounded single or three-phase AC supplies and a protective conductor.

Ungrounded, i. e. isolated networks (IT networks) are always used where high demands are placed on the reliability of the power supply, e. g. emergency lighting systems. IT systems are supplied via an isolating transformer or by power supplies such as batteries or a generator. While an initial insulation fault between a phase conductor and the ground effectively grounds the conductor, as a result no circuit has been closed, so it is possible to continue work in safety (single-fault safety). However, the fault must be rectified as quickly as possible before a second insulation fault occurs (e. g. according to DIN VDE 0100-410). For this purpose insulation monitoring relays are used, which constantly measure the resistance to ground of the phase conductor and the neutral conductor, reporting a fault immediately if insulation resistance falls below the set value so that either a controlled shutdown can be performed or the fault can be rectified without interrupting the power supply.

Two series

- 3UG45 81 insulation monitoring relays for ungrounded AC networks
- 3UG45 82, 3UG45 83 insulation monitoring relays for ungrounded DC and AC networks

Benefits

- Devices for AC and DC systems
- All devices have a wide control supply voltage range
- Direct connection to networks with mains voltages of up to 690 V AC and 1000 V DC by means of a voltage reducer module
- For AC mains: Frequency range 15 ... 400 Hz
- Monitoring of broken conductors
- Monitoring of setting errors
- Safety in use thanks to integrated system test after startup
- Option of resetting and testing (by means of pushbutton on front or using control contact)
- New predictive measurement principle allows very fast response times

Application

IT networks are used for example:

- In emergency power supplies
- In safety lighting systems
- In industrial production facilities with high availability requirements (chemical industry, automobile manufacturing, printing plants)
- In shipping and railways
- For mobile generators (aircraft)
- For renewable energies, such as wind energy and photovoltaic power plants
- In the mining industry

Insulation monitoring

Technical specifications

General data

Type	3UG45 81-1AW30	3UG45 82-1AW30	3UG45 83-1AW30
Setting range for the setpoint response values • 1 ... 100 kΩ • 2 ... 200 kΩ	✓ --	✓ --	✓ ✓
Rated voltage of the network being monitored • 0 ... 250 V AC • 0 ... 440 V AC • 0 ... 690 V AC • 0 ... 300 V DC • 0 ... 600 V DC • 0 ... 1000 V DC	-- ✓ -- -- -- --	✓ -- -- ✓ -- --	-- ✓ ✓ ¹⁾ -- -- ✓ ¹⁾
Max. leakage capacitance of the system • 10μ F • 20μ F	✓ --	✓ --	-- ✓
Output contacts • 1 CO • 2 CO or 1 CO + 1 CO, adjustable	✓ --	✓ --	-- ✓
Number of limit values • 1 • 1 or 2, adjustable	✓ --	✓ --	-- ✓
Principle of operation	Closed-circuit principle	Closed-circuit principle	Open-circuit/closed-circuit principle, adjustable
Rated control supply voltage • 24 ... 240 V AC/DC	✓	✓	✓
Rated frequency • 13.5 ... 440 Hz • 45 ... 65 Hz	-- ✓	-- ✓	✓ --
Auto or manual RESET	✓ Adjustable	✓ Adjustable	✓ Adjustable
Remote-RESET	✓ Via control input	✓ Via control input	✓ Via control input
Non-volatile error memory	--	--	✓ Adjustable
Broken wire detection	--	--	✓ Adjustable
Replacement for			
Rated control supply voltage U_s	Voltage range of the network being monitored		
3UG30 81-1AK20 110 ... 130/220 ... 240 V AC/DC	3 x 230/400 V AC		✓ --
3UG30 81-1AW30 24 ... 240 V AC/DC	3 x 230/400 V AC		✓ --
3UG30 82-1AW30 24 ... 240 V AC/DC	24 ... 240 V DC	✓	--

✓ Available

-- Not available

¹⁾ With voltage reducer module.

Overview



SIRIUS 3UG45 81 insulation monitor

The 3UG45 81 insulation monitoring relays are used to monitor insulation resistance in accordance with IEC 61557-8 in ungrounded AC networks with rated voltages of up to 400 V.

These devices can monitor control circuits (single-phase) and main circuits (three phase).

They measure insulation resistances between system cables and system ground. If the value falls below the threshold value, the output relays are switched to fault status.

In the case of 3UG45 81 a higher-level DC measuring signal is used. The higher-level DC measuring signal and the resulting current are used to determine the value of the insulation resistance of the network which is to be measured.

Technical specifications

3UG45 81 monitoring relays

With the closed-circuit principle selected

Insulation resistance monitoring without fault storage, with auto RESET

Insulation resistance monitoring with fault storage and manual RESET

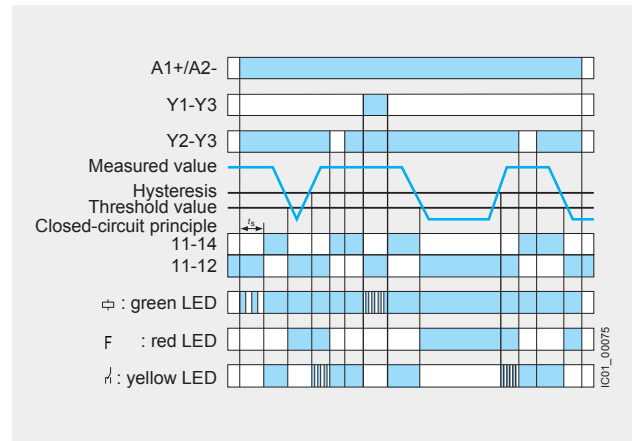
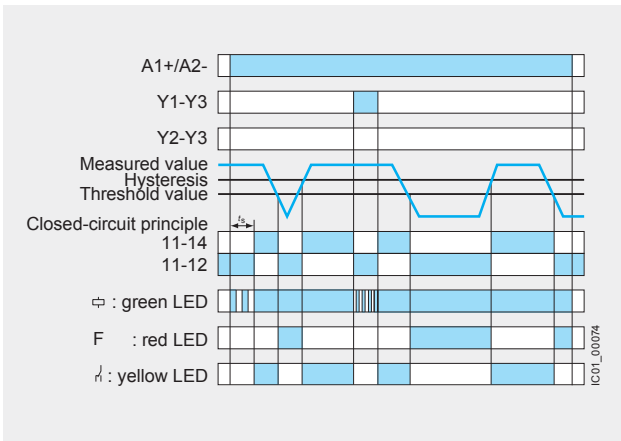



Function Relays, Interfaces and Converters

SIRIUS 3UG Monitoring Relays for Stand-Alone Installation

SIRIUS
RELAYS

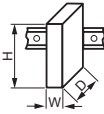
Insulation monitoring
for ungrounded AC networks

Type	3UG45 81	
Dimensions (W x H x D)	mm	22.5 x 100 x 100
		
Connection type	 Screw terminals	
<ul style="list-style-type: none"> • Solid • Finely stranded with end sleeve • AWG cables, solid or stranded 	mm ² mm ² AWG	2 x (0.5 ... 4) 2 x (0.75 ... 2.5) 2 x (20 ... 14)
General data		
Rated insulation voltage U_i	V	400 supply circuit/measuring circuit 300 supply circuit/output circuit
Pollution degree 3 Overvoltage category III acc. to IEC 60664		
Rated impulse withstand voltage	kV	6
Rated control supply voltage	V	24 ... 240 AC/DC
Rated frequency	Hz	15 ... 400
Measuring circuit		
Rated system voltage of the network being monitored	V	0 ... 400
Rated frequency of the network being monitored	Hz	50 ... 60
Setting range for insulation resistance	k Ω	1 ... 100
Control circuit		
Load capacity of the output relay	<ul style="list-style-type: none"> • Conventional thermal current I_{th} 	
	A	4
Rated operational current I_e at	<ul style="list-style-type: none"> • AC-15/24 ... 400 V • DC-13/24 V 	
	A	3
	A	2
Minimum contact load at 24 V DC	mA	10

Circuit diagram

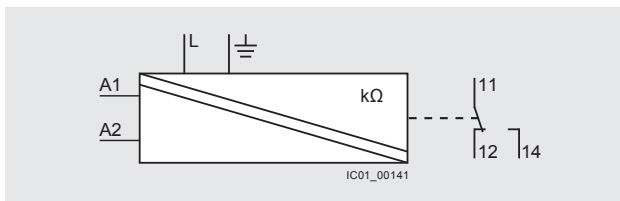

3UG45 81

Note:

It is not necessary to protect the measuring circuit for device protection. The protective device for line protection depends on the cross-section used.

Connection diagrams for networks up to 400 V AC

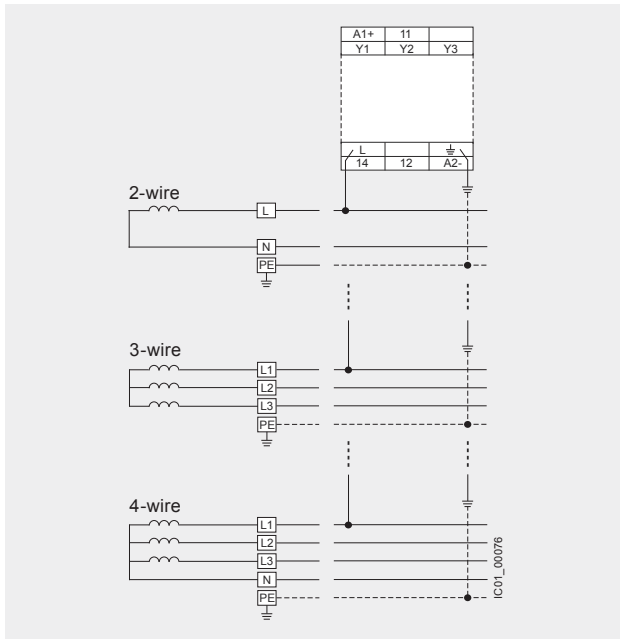

Selection and ordering data

- Auto or manual RESET
- Closed-circuit principle
- 1 CO contact
- Fault memory adjustable using control input (S2-S3)
- Reset by means of pushbutton on front or using control input (S2-S3)
- Test by means of pushbutton on front or using control input (S1-S3)

Rated system voltage U_n	Measuring range U_e	Rated control supply voltage U_s	System leakage capacitance	DT	Screw terminals	PU (UNIT, SET, M)	PS*	PG
V AC	kΩ	V	μF		Order No.	Price per PU		

Insulation monitors for ungrounded AC networks

0 ... 400	1 ... 110	24 ... 240 AC/DC	max. 10	B	3UG45 81-1AW30		1	1 unit	41H
-----------	-----------	------------------	---------	---	-----------------------	--	---	--------	-----



3UG45 81-1AW30

Function Relays, Interfaces and Converters

SIRIUS 3UG Monitoring Relays for Stand-Alone Installation

SIRIUS
RELAYS

Insulation monitoring for ungrounded
DC and AC networks

Overview

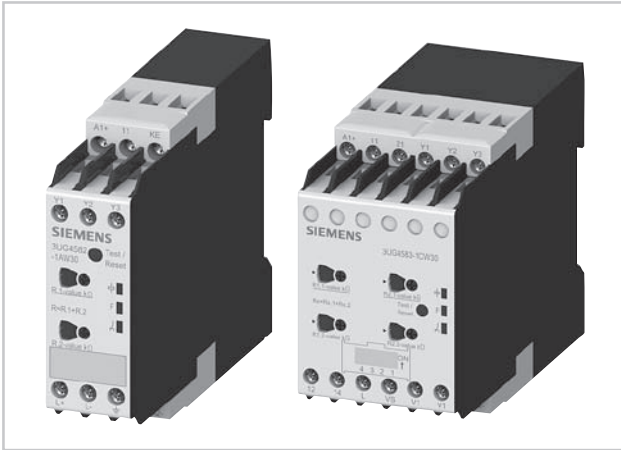

SIRIUS 3UG45 82 and 3UG45 83 insulation monitors

The 3UG45 82 and 3UG45 83 insulation monitoring relays are used to monitor insulation resistance in ungrounded IT AC or DC networks in accordance with IEC 61557-8.

They measure insulation resistances between system cables and system ground. If the value falls below the threshold value, the output relays are switched to fault status. With these devices, which are suitable for both AC and DC networks, a pulsed test signal is fed into the network to be monitored and the isolation resistance is determined.

The pulsed test signal changes its form according to insulation resistance and network loss capacitance. The changed form is used to predict the changed insulation resistance.

If the predicted insulation resistance matches the insulation resistance calculated in the next measurement cycle, and is lower than the threshold value, the output relays are activated or deactivated, depending on the device configuration. This measurement principle is also suitable for identifying symmetrical insulation faults.

3UG49 83 voltage reducer modules

The 3UG49 83 passive voltage reducer module can be used to allow the 3UG45 83 insulation monitoring relay to be used for insulation monitoring of IT networks with rated voltages of up to 690 V AC and 1000 V DC.

Technical specifications

3UG45 82 monitoring relays

With the closed-circuit principle selected

Insulation resistance monitoring without fault storage, with auto RESET

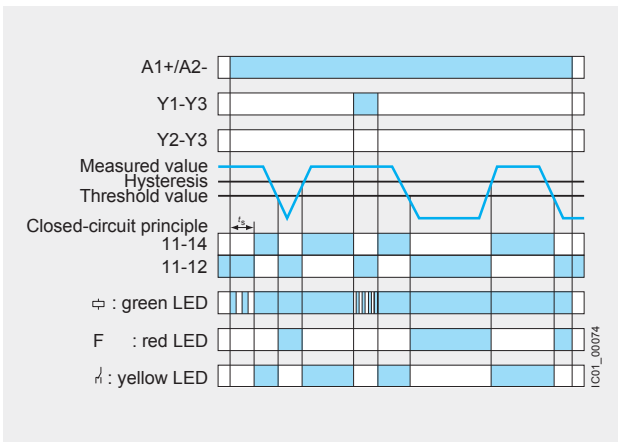

Insulation resistance monitoring with fault storage and manual RESET

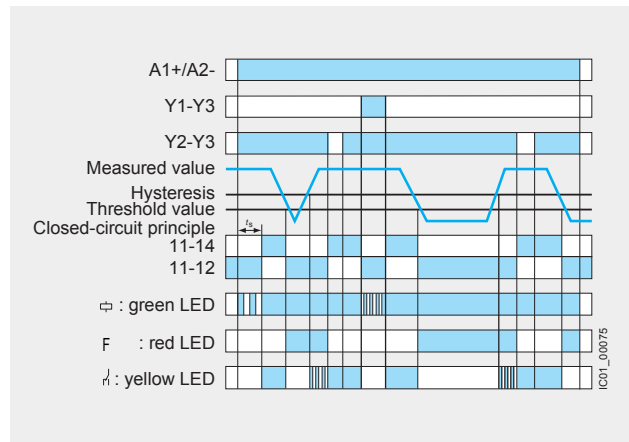

3UG45 83 monitoring relays

With the closed-circuit principle selected

Insulation resistance monitoring without fault storage, with auto RESET

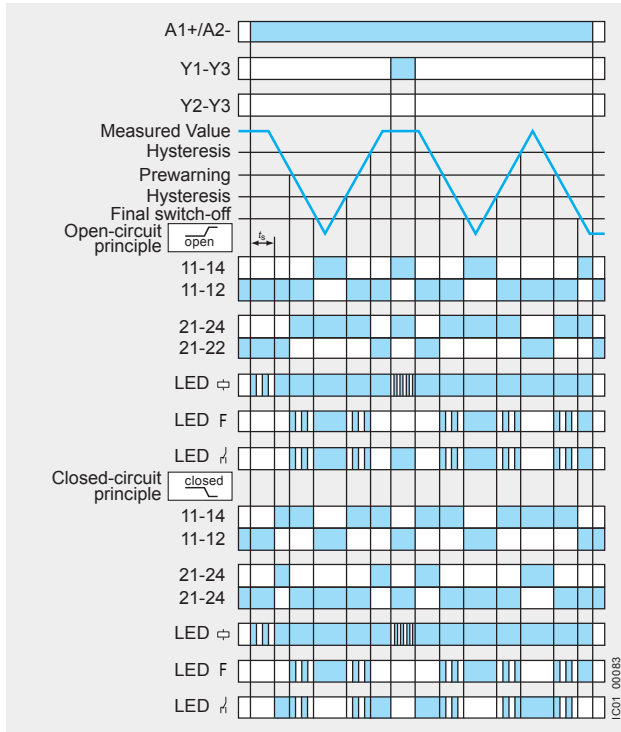

Insulation resistance monitoring with fault storage and manual RESET

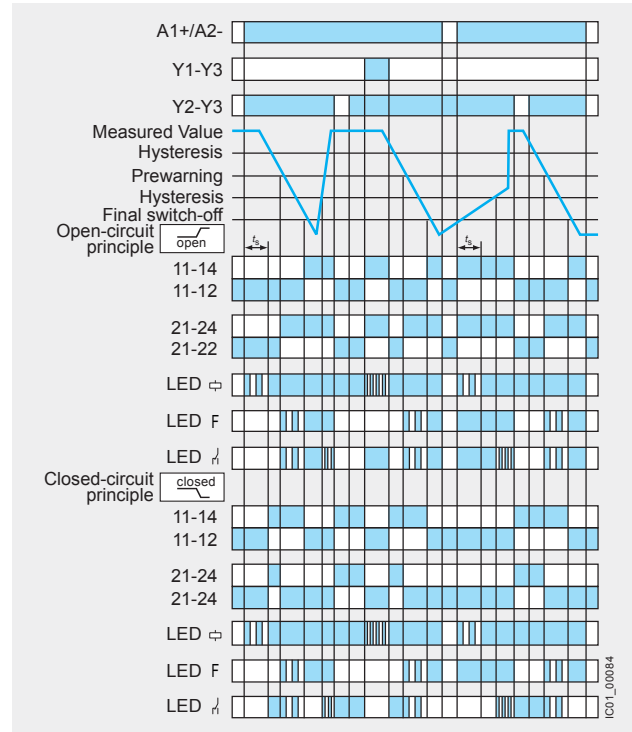

Type		3UG45 82	3UG45 83
Dimensions (W x H x D)	mm	22.5 x 100 x 100	45 x 100 x 100
Connection type		Screw terminals	
<ul style="list-style-type: none"> Solid Finely stranded with end sleeve AWG cables, solid or stranded 	mm ² mm ² AWG	2 x (0.5 ... 4) 2 x (0.75 ... 2.5) 2 x (20 ... 14)	
General data			
Rated insulation voltage U_i	V	400 supply circuit/measuring circuit	400 supply circuit/measuring circuit
Pollution degree 3		300 supply circuit/output circuit	300 supply circuit/output circuit,
Overvoltage category III acc. to IEC 60664			300 output circuit 1/output circuit 2
Rated impulse withstand voltage	kV	6	
Rated control supply voltage	V	24 ... 240 AC/DC	
Rated frequency	Hz	15 ... 400	
Measuring circuit			
Rated system voltage of the network being monitored	V	0 ... 250 AC, 0 ... 300 DC	0 ... 300 AC, 0 ... 690 AC with 3UG49 83 0 ... 600 DC, 0 ... 1000 DC with 3UG49 83
Rated frequency of the network being monitored	Hz	DC or 15 ... 400	
Setting range for insulation resistance	kΩ	1 ... 100	1 ... 100 2 ... 200 for 2nd limit value (disconnectable)
Control circuit			
Number of CO contacts for auxiliary contacts		1	2 or 1 + 1, adjustable
Load capacity of the output relay			
<ul style="list-style-type: none"> Conventional thermal current I_{th} 	A	4	
Rated operational current I_e at			
<ul style="list-style-type: none"> AC-15/24 ... 400 V DC-13/24 V 	A	3	
	A	2	
Minimum contact load at 24 V DC	mA	10	

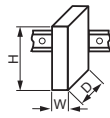

Function Relays, Interfaces and Converters

SIRIUS 3UG Monitoring Relays for Stand-Alone Installation

SIRIUS
RELAYS

Insulation monitoring for ungrounded
DC and AC networks

Circuit diagrams

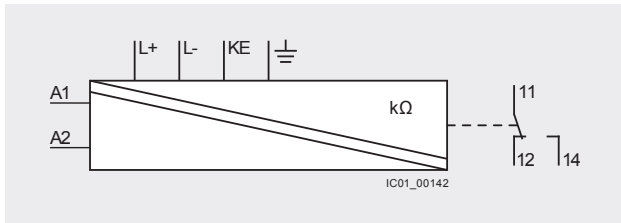

3UG45 82

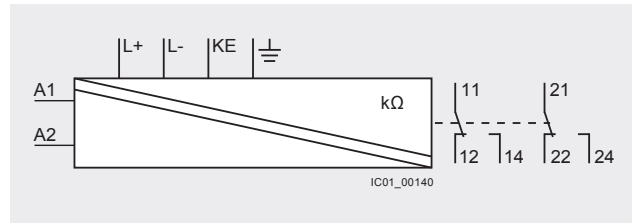

3UG45 83

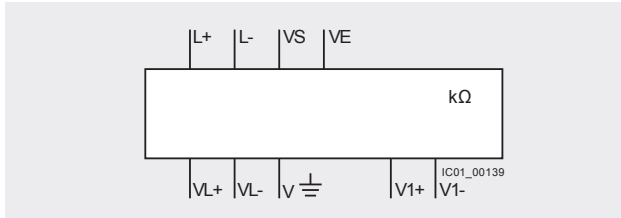

3UG49 83

Note:

It is not necessary to protect the measuring circuit for device protection. The protective device for line protection depends on the cross-section used.

Connection diagrams

3UG45 82

AC network, 2-wire, 3-wire or 4-wire

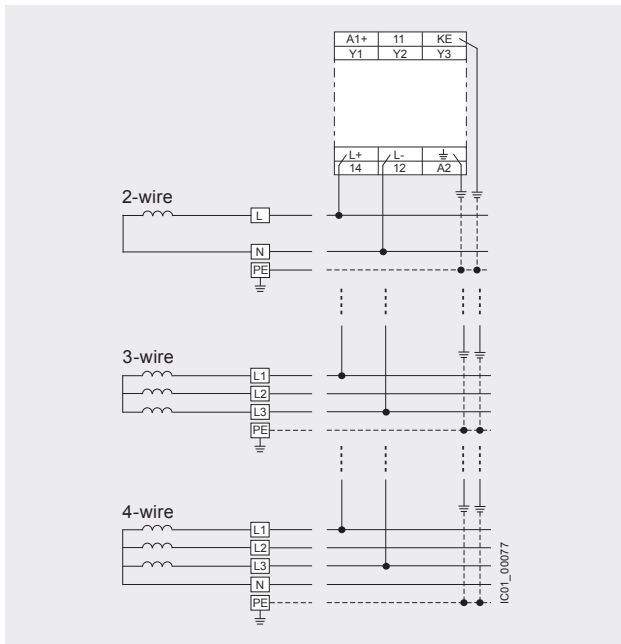

DC network, 2-wire or 3-wire

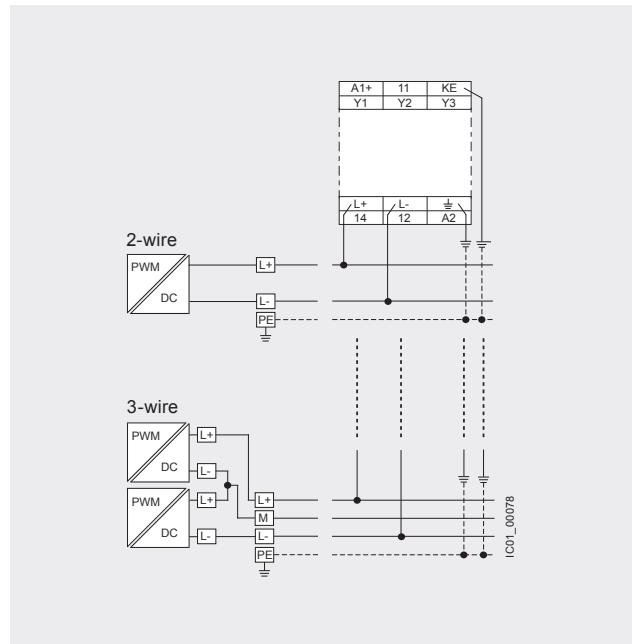

Note:

L+ and L- can be connected to any wire, but each to a different wire. $U_n \leq 250$ V AC or 300 V DC.

3UG45 83

AC network, 2-wire, 3-wire or 4-wire

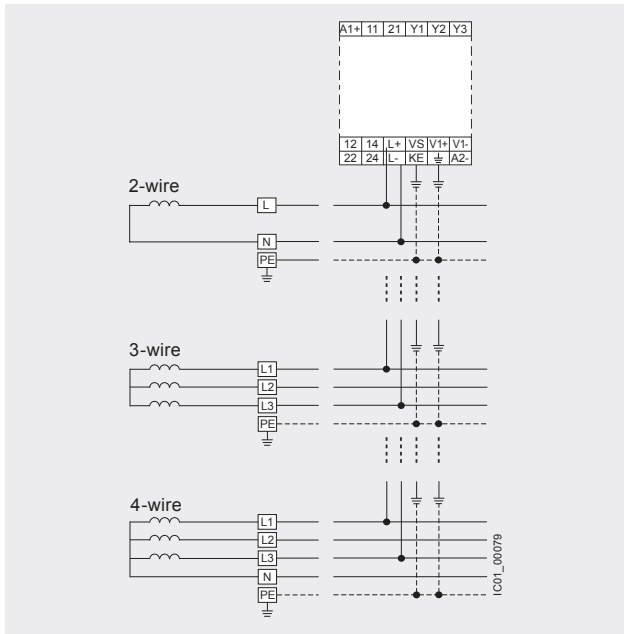

DC network, 2-wire or 3-wire

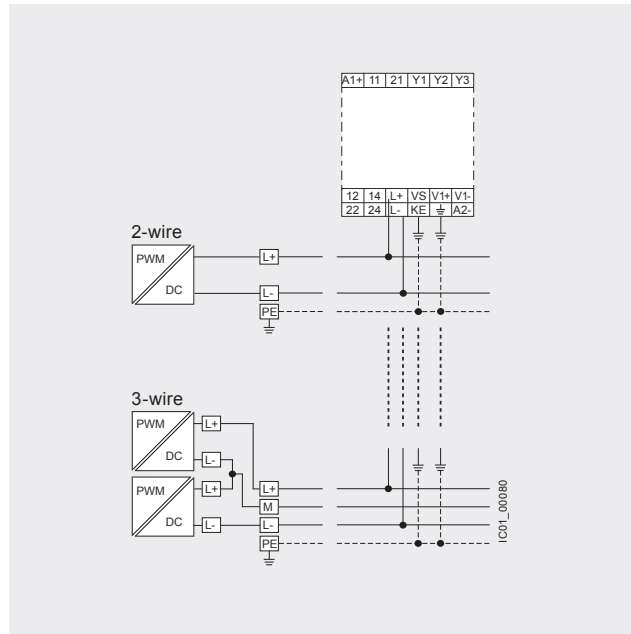

Note:

L+ and L- can be connected to any wire, but each to a different wire. $U_n \leq 400$ V AC or 600 V DC. Use a voltage reducer module to monitor systems with higher voltages.

3UG49 83 voltage reducer modules

AC network, 2-wire, 3-wire or 4-wire

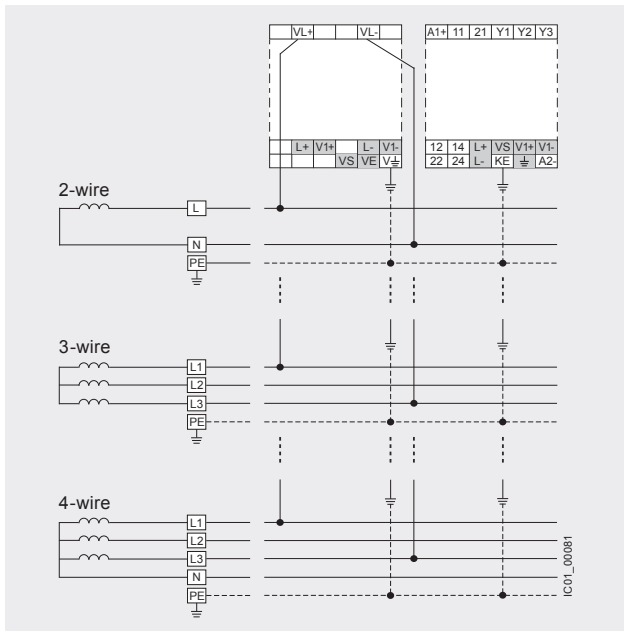

DC network, 2-wire or 3-wire

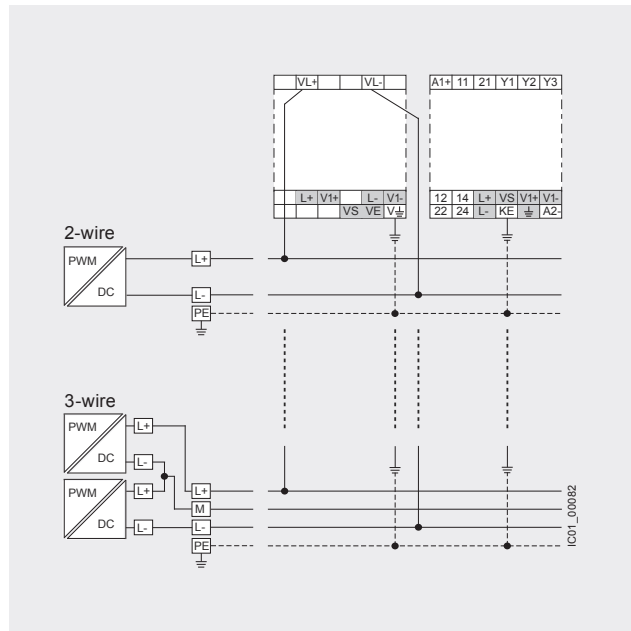

Note:

L+ and L- can be connected to any wire, but each to a different wire. $U_n \leq 400$ V AC or 600 V DC. Use a voltage reducer module to monitor systems with higher voltages.

Function Relays, Interfaces and Converters

SIRIUS 3UG Monitoring Relays for Stand-Alone Installation

SIRIUS
RELAYS

Insulation monitoring for ungrounded
DC and AC networks

Selection and ordering data

- Auto or manual RESET
- 3UG45 82: Open-circuit principle
- 3UG45 83: Open-circuit or closed-circuit principle, adjustable
- 1 or 2 CO contacts
- Fault memory adjustable using control input (S2-S3)
- Reset by means of pushbutton on front or using control input (S2-S3)
- Test by means of pushbutton on front or using control input (S1-S3)
- 3UG45 83: Non-volatile fault storage can be configured
- 3UG45 83: 2 separate limit values (e.g. for warning and disconnection) or 2 CO contacts for one limit value (e.g. for a local alarm and signaling to the PLC via separate circuits) can be configured

Note:

With the 3UG49 83-1A coupling unit, connection to networks with a voltage of up to 690 V AC and 1000 V DC is possible, [see below](#).

Rated system voltage U_n	System leakage capacitance	Output relay	Measuring range U_e	Broken wire detection in the measuring range	DT	Screw terminals 	PU (UNIT, SET, M)	PS*	PG
V	μF		k Ω			Order No.	Price per PU		
SIRIUS 3UG45 82 insulation monitors									
0 ... 250 AC	max. 10	1 CO	1 ... 110	✓	B	3UG45 82-1AW30	1	1 unit	41H
SIRIUS 3UG45 83 insulation monitors									
0 ... 400 AC, 0 ... 600 DC ¹⁾	max. 20	2 CO or 1 CO + 1 CO, adjustable	1 ... 110, 2 ... 200 for 2nd limit value, adjustable	✓ adjustable	B	3UG45 83-1CW30	1	1 unit	41H
3UG45 83 voltage reducer modules									
For extending the mains voltage range to max. 690 V AC and 1000 V DC					B	3UG49 83-1A	1	1 unit	41H



3UG45 82-1AW30



3UG45 83-1AW30



3UG49 83-1A

✓ Available

¹⁾ With 3UG49 83-1A voltage reducer module suitable also for the insulation monitoring of IT networks up to 690 V AC and 1000 V DC.

Overview



The 3UG45 01 level monitoring relay is used together with 2- or 3-pole sensors to monitor the levels of conductive liquids.

Application

- Single-point and two-point level monitoring
- Overflow protection
- Dry run protection
- Leak monitoring

Selection and ordering data

- Level monitoring relay for conductive liquids
- Control principle: inlet or outlet control per rotary switch
- Single-point and two-point control possible
- Analog adjustable sensitivity (specific resistance of the liquid)
- Analog adjustable tripping delay time
- 1 yellow LED for indicating the relay state
- 1 green LED for indicating the applied control supply voltage
- 1 CO contact
- All terminals are removable
- Width 22.5 mm

Sensitivity	Tripping delay time	Rated control supply voltage U_s	Screw terminals 	PU (UNIT, SET, M)	PS*	Weight per PU approx.
k Ω	s	V AC/DC	Order No. List Price \$ per PU			kg
2 ... 200	0.5 ... 10	24 ¹⁾ 24 ... 240	3UG45 01-1AA30 3UG45 01-1AW30	1 1	1 unit 1 unit	0.110 0.120

Sensitivity	Tripping delay time	Rated control supply voltage U_s	Spring-type terminals 	PU (UNIT, SET, M)	PS*	Weight per PU approx.
k Ω	s	V AC/DC	Order No. List Price \$ per PU			kg
2 ... 200	0.5 ... 10	24 ¹⁾ 24 ... 240	3UG45 01-2AA30 3UG45 01-2AW30	1 1	1 unit 1 unit	0.110 0.120

For level monitoring sensors see page 11/56

¹⁾ The rated control supply voltage and the measuring circuit are not electrically isolated.





Function Relays, Interfaces and Converters

3UG Monitoring Relays

SIRIUS RELAYS

Level monitoring:
Level monitoring sensors

Selection and ordering data

Version	Assignment Cable	Elec- trode	Application	Order No.	List Price \$ per PU	PU (UNIT, SET, M)	PS*	Weight per PU approx. kg
Level monitoring sensors (essential accessory)								
 3UG32 07-3A	Three-pole wire electrodes 500 mm long, with Teflon insulation (PTFE), screw-in gland width A/F 22, 3/8 inch thread, PVC connecting cable, 3 x 0.5 mm ² , 2 m long, max. operating temperature 90 °C, max. operating pressure 10 bar	Brown White Green	Center electrode Not assignable	The electrodes can be cut or bent to the required length before or after installation. The Teflon insulation must be removed over a length of approx. 5 mm. Applications: For 2-point liquid level control in an insulating tank. One electrode each for the min. and max. value and a common reference electrode.	3UG32 07-3A		1 1 unit	0.254
 3UG32 07-2A	Two-pole wire electrodes 500 mm long, with Teflon insulation (PTFE), screw-in gland width A/F 22, 3/8 inch thread, PVC connecting cable, 3 x 0.5 mm ² , 2 m long, max. operating temperature 90 °C, max. operating pressure 10 bar	Brown White	Not assignable	For installation see 3UG32 07-3A Application: For alarm indication in the event of overflow or low level and for 2-point liquid level control, when the conductive tank is used as the reference electrode.	3UG32 07-2A		1 1 unit	0.230
 3UG32 07-2B	Two-pole bow electrodes with Teflon insulation (PTFE), screw-in gland width A/F 22, 3/8 inch thread, PVC connecting cable, 3 x 0.5 mm ² , 2 m long, max. operating temperature 90 °C, max. operating pressure 10 bar	Brown White Green	Gland Not assignable	Thanks to the small space requirements due to lateral fitting, ideal for use in small containers and pipes, as a leak monitor and level monitor or for warning of water entering an enclosure.	3UG32 07-2B		1 1 unit	0.128
 3UG32 07-1B	Single-pole bow electrodes for lateral fitting with Teflon insulation (PTFE), screw-in gland width A/F 22, 3/8 inch thread, PVC connecting cable, 3 x 0.5 mm ² , 2 m long, max. operating temperature 90 °C, max. operating pressure 10 bar	Brown White	Gland Electrode	As a max. value electrode for lateral fitting or for alarm indication in conductive tanks or pipes.	3UG32 07-1B		1 1 unit	0.122
 3UG32 07-1C	Single-pole rod electrodes for lateral fitting with Teflon insulation (PTFE), screw-in gland width A/F 22, 3/8 inch thread, PVC connecting cable, 3 x 0.5 mm ² , 2 m long, max. operating temperature 90 °C, max. operating pressure 10 bar	Brown White	Gland Electrode	For high flow velocities or for intensively sparkling fluids.	3UG32 07-1C		1 1 unit	0.144

Technical specifications

Type		3UG45 01-1AA30, 3UG45 01-2AA30	3UG45 01-1AW30, 3UG45 01-2AW30
General data			
Rated control supply voltage U_s	V AC/DC	24	24 ... 240
Rated frequency	Hz	50/60	
Operating range	V	20.4 ... 26.4	20.4 ... 264
Rated power, max.			
• At 24 V AC	VA	2	2
• At 240 V AC	VA	--	4
Width	mm	22.5	
Availability time after application of U_s	ms	500	
Response time once a switching threshold is reached	ms	Max. 300	
Adjustable delay time	s	0.5 ... 10	
Inlet or outlet monitoring function		UNDER/OVER selector switch at the front	
Mains buffering time, minimum	ms	200	
Rated insulation voltage U_i	V	300	
Degree of pollution 3, Overvoltage category III acc. to EN 60664-1			
Rated impulse withstand voltage	kV	4	
Permissible ambient temperature			
• During operation	°C	-25 ... +60	
• During storage	°C	-40 ... +80	
EMC tests ¹⁾		IEC 60947-1/IEC 61000-6-2/IEC 61000-6-4	
Degree of protection			
• Enclosure (acc. to EN 60529)		IP40	
• Terminals		IP20	
Vibration resistance acc. to IEC 60068-2-6		1 ... 6 Hz: 15 mm; 6 ... 500 Hz: 2 g	
Shock resistance acc. to IEC 60068-2-27		12 shocks (half-sine 15 g/11 ms)	
Connection type		⊕ Screw terminals	
• Terminal screw		M3 (for standard screwdriver, size 2 and Pozidriv 2)	
• Solid	mm ²	1 x (0.5 ... 4)/2 x (0.5 ... 2.5)	
• Finely stranded with end sleeve	mm ²	1 x (0.5 ... 2.5)/2 x (0.5 ... 1.5)	
• AWG cables, solid or stranded	AWG	2 x (20 ... 14)	
• Tightening torque	Nm	0.8 ... 1.2	
Connection type		⊖ Spring-type terminals	
• Solid	mm ²	2 x (0.25 ... 1.5)	
• Finely stranded, with end sleeves acc. to DIN 46228	mm ²	2 x (0.25 ... 1.5)	
• Finely stranded	mm ²	2 x (0.25 ... 1.5)	
• AWG cables, solid or stranded	AWG	2 x (24 ... 16)	
Measuring circuit			
Electrode current, max. (typ. 70 Hz)	mA	1	
Electrode voltage, max. (typ. 70 Hz)	V	15	
Sensor feeder cable	m	Max. 100	
Conductor capacity of sensor cable ²⁾	nF	Max. 10	
Adjustable sensitivity			
• Resistance	kΩ	2 ... 200	
Measuring accuracy	%	±20	
Repeat accuracy at constant parameters	%	±1	
Deviations for temperature fluctuations	%/°C	±1	
Control circuit			
Number of CO contacts for auxiliary contacts		1	
Load capacity of the output relay			
Conventional thermal current I_{th}	A	5	
Rated operational current I_o at			
• AC-15/24 ... 400 V	A	3	
• DC-13/24 V	A	1	
• DC-13/125 V	A	0.2	
• DC-13/250 V	A	0.1	
Minimum contact load at 17 V DC	mA	5	
Output relay with DIAZED fuse	A	4	
gL/gG operational class			
Electrical endurance AC-15	Million operating cycles	0.1	
Mechanical endurance	Million operating cycles	10	

¹⁾ Important: This is a Class A product. In the household environment this device may cause radio interference. In this case the user must introduce suitable measures.

²⁾ The sensor cable does not necessarily have to be shielded, but we do not recommend installing this cable parallel to the power supply lines. It is also possible to use a shielded cable, whereby the shield has to be connected to the M terminal.

Dimensional drawings

3UG45 01

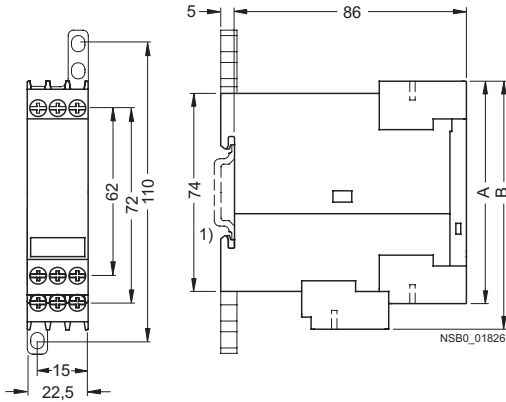

Type	3UG45 01	
	A	B

Removable terminals

Screw terminals	83	92
Spring-loaded terminals	84	94

1) For standard mounting rail according to EN 60715.

Schematics

3UG45 01

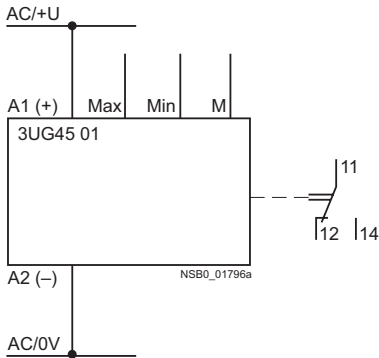

Single-point control with inlet monitoring

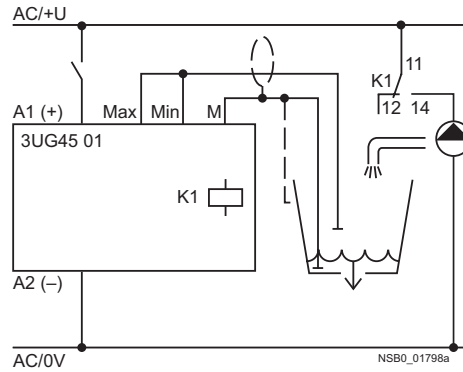

Two-point control with outlet monitoring

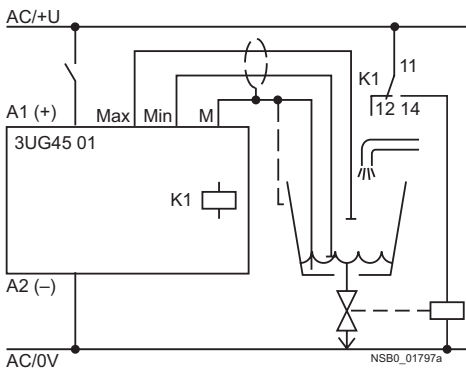

Position of the terminals

A1+	M
MIN	MAX
12	11
A2-	14

NSB0_011823

Technical specifications

Type		3UG32 07-3A three-pole	3UG32 07-2A two-pole	3UG32 07-2B two-pole	3UG32 07-1B single-pole	3UG32 07-1C single-pole
Length	mm	500	500	--	--	--
Insulation	Teflon insulation (PTFE)	Yes	Yes	Yes	--	Yes
Installation		Vertical	Vertical	Lateral	Lateral	Lateral
Screw-in gland width A/F		22				
Thread	inch	R 3/8				
Connecting cable	mm ²	3 x 0.5, 2 m long				
Operating temperature	°C	90				
Operating pressure	bar	10				
Assignment Cable/Electrode	• Cable brown	Center electrode	Not assignable	Gland	Gland	Gland
	• Cable white	Not assignable	Not assignable	Not assignable	Electrode	Electrode
	• Cable green	Not assignable	--	Not assignable	--	--

Dimensional drawings

3UG32 07-3A
three-pole wire electrode

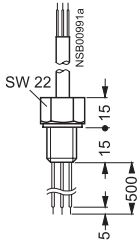

3UG32 07-1B
single-pole bow electrode

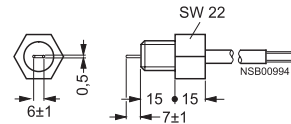

3UG32 07-2A
two-pole wire electrode

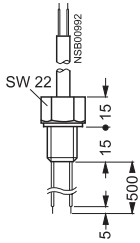

3UG32 07-1C
single-pole electrode, rugged version

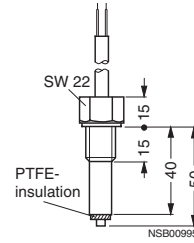

3UG32 07-2B
two-pole bow electrode

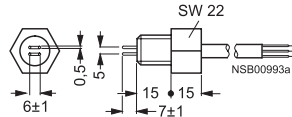

Speed monitoring

Overview

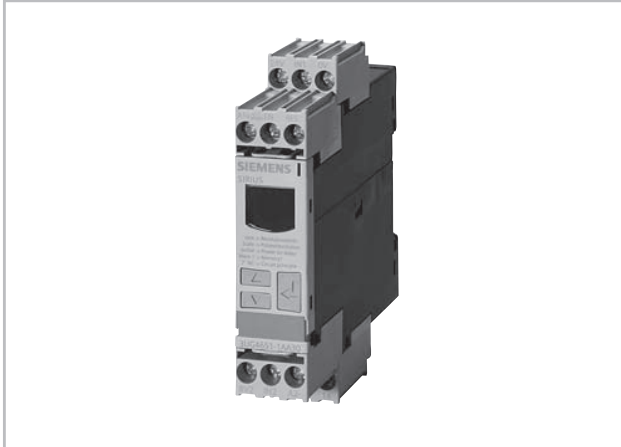

The 3UG46 51 monitoring relay is used together with a sensor to monitor drives for overspeed and/or underspeed.

Furthermore, this relay is ideal for all functions where a continuous pulse signal needs to be monitored (e. g. belt travel monitoring, completeness monitoring, passing monitoring, clock-time monitoring).

Application

- Slip or tear of a belt drive
- Overload monitoring
- Transport monitoring for completeness

Selection and ordering data

- Relay for speed monitoring in min^{-1} (rpm)
- Two- or three-wire sensor with mechanical or electronic switching output can be connected
- Two-wire NAMUR sensor can be connected
- Integrated sensor supply 24 V DC/50 mA
- Input frequency 0.1 ... 2200 pulses min^{-1} (0.0017 ... 36.7 Hz)
- With or without enable signal for the drive to be monitored



- Digital adjustable, with illuminated LCD
- Overshoot, undershoot or range monitoring
- Number of pulses per revolution can be adjusted
- Upper and lower threshold value can be adjusted separately
- Auto, manual or remote RESET options after tripping
- Permanent display of actual value and tripping state
- 1 CO contact
- All terminals are removable
- Width 22.5 mm

Measuring range	Hysteresis	ON-delay time	Tripping delay time	Pulses per revolution	Rated control supply voltage U_s AC/DC	Screw terminals 	PU (UNIT, SET, M)	PS*	Weight per PU approx.
rpm	rpm	s	s		V	Order No.	List Price \$ per PU		kg
0.1 ... 2200	OFF, 0.1 ... 99.9	0 ... 900	0.1 ... 99.9	1 ... 10	24 ¹⁾ 24 ... 240	3UG46 51-1AA30 3UG46 51-1AW30	1 1	1 unit 1 unit	0.120 0.130

Measuring range	Hysteresis	ON-delay time	Tripping delay time	Pulses per revolution	Rated control supply voltage U_s AC/DC	Spring-type terminals 	PU (UNIT, SET, M)	PS*	Weight per PU approx.
rpm	rpm	s	s		V	Order No.	List Price \$ per PU		kg
0.1 ... 2200	OFF, 0.1 ... 99.9	0 ... 900	0.1 ... 99.9	1 ... 10	24 ¹⁾ 24 ... 240	3UG46 51-2AA30 3UG46 51-2AW30	1 1	1 unit 1 unit	0.120 0.130

¹⁾ The rated control supply voltage and the measuring circuit are not electrically isolated.

Technical specifications

Type		3UG46 51-1AA30, 3UG46 51-2AA30	3UG46 51-1AW30, 3UG46 51-2AW30
General data			
Rated control supply voltage U_s	V AC/DC	24	24 ... 240
Rated frequency	Hz	50/60	
Operating range	V	20.4 ... 26.4	20.4 ... 264
Rated power, max.			
• At 24 V AC	VA	2.5	4
• At 240 V AC	VA	--	9
Width	mm	22.5	
RESET		Automatic/manual	
Availability time after application of U_s	ms	500	
Response time once a switching threshold is reached	ms	Max. 300	
Adjustable tripping delay time	s	0.1 ... 99.9	
Adjustable ON-delay time	s	1 ... 900	
Principle of operation		Closed-circuit principle, open-circuit principle	
NC/NO contact behavior		Adjustable	
Mains buffering time, minimum	ms	10	
Rated insulation voltage U_i Degree of pollution 3, Overvoltage category III acc. to EN 60664-1	V	300	
Rated impulse withstand voltage	kV	4	
Permissible ambient temperature			
• During operation	°C	-25 ... +60 ¹⁾	
• During storage	°C	-40 ... +80	
EMC tests ²⁾		IEC 60947-1, IEC 61000-6-2, IEC 61000-6-4	
Degree of protection			
• Enclosure (acc. to EN 60529)		IP40	
• Terminals		IP20	
Vibration resistance acc. to IEC 60068-2-6		1 ... 6 Hz: 15 mm; 6 ... 500 Hz: 2 g	
Shock resistance acc. to IEC 60068-2-27		12 shocks (half-sine 15 g/11 ms)	
Connection type		 Screw terminals	
• Terminal screw		M3 (for standard screwdriver, size 2 and Pozidriv 2)	
• Solid	mm ²	1 x (0.5 ... 4)/2 x (0.5 ... 2.5)	
• Finely stranded with end sleeve	mm ²	1 x (0.5 ... 2.5)/2 x (0.5 ... 1.5)	
• AWG cables, solid or stranded	AWG	2 x (20 ... 14)	
• Tightening torque	Nm	0.8 ... 1.2	
Connection type		 Spring-type terminals	
• Solid	mm ²	2 x (0.25 ... 1.5)	
• Finely stranded, with end sleeves acc. to DIN 46228	mm ²	2 x (0.25 ... 1.5)	
• Finely stranded	mm ²	2 x (0.25 ... 1.5)	
• AWG cables, solid or stranded	AWG	2 x (24 ... 16)	
Measuring circuit			
Sensor supply			
• For three-wire sensor (24 V/0 V)	mA	Max. 50	
• For 2-wire NAMUR sensor (8V2)	mA	Max. 8.2	
Signal input			
• IN1	kΩ	16, three-wire sensor, pnp operation	
• IN2	kΩ	1, floating contact, 2-wire NAMUR sensor	
Voltage level			
• For level 1 at IN1	V	4.5 ... 30	
• For level 0 at IN1	V	0 ... 1	
Current level			
• For level 1 at IN2	mA	> 2.1	
• For level 0 at IN2	mA	< 1.2	
Minimum pulse duration of signal	ms	5	
Minimum interval between 2 pulses	ms	5	
Adjustable response value rpm	rpm	0.1 ... 2200	
Hysteresis	rpm	OFF and 0.1 ... 99.9	
Scale		1 ... 10	
Measuring accuracy	%	±10	
Repeat accuracy at constant parameters	%	±1	
Accuracy of digital display		±1 digit	

¹⁾ At a distance of > 1 cm to adjacent devices;
if butt-mounted: +50 °C.

²⁾ Important: This is a Class A product. In the household environment this device may cause radio interference. In this case the user must introduce suitable measures.

Speed monitoring

Type	3UG46 51-1AA30, 3UG46 51-2AA30	3UG46 51-1AW30, 3UG46 51-2AW30
Control circuit		
Number of CO contacts for auxiliary contacts		1
Load capacity of the output relay		
Conventional thermal current I_{th}	A	5
Rated operational current I_e at		
• AC-15/24 ... 400 V AC/DC	A	3
• DC-13/24 V	A	1
• DC-13/125 V	A	0.2
• DC-13/250 V	A	0.1
Minimum contact load at 17 V DC	mA	5
Output relay with DIAZED fuse gL/gG operational class	A	4
Electrical endurance AC-15	Million operating cycles	0.1
Mechanical endurance	Million operating cycles	10

Dimensional drawings

3UG46 51

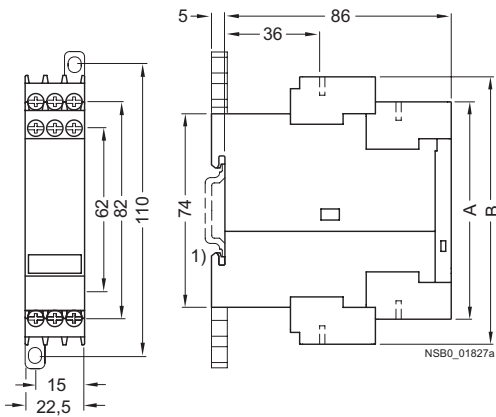

Type	3UG46 51	A	B
------	----------	---	---

Removable terminal

Screw-type terminal	83	102
Spring-loaded terminal	84	103

1) For standard mounting rail according to EN 60715.

Schematics

3UG46 51

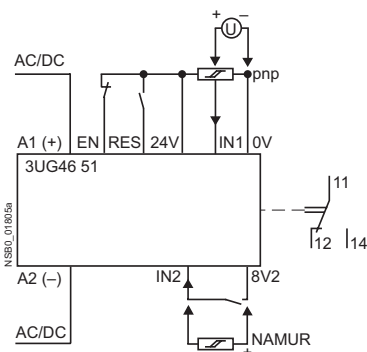

Circuit example without enable input

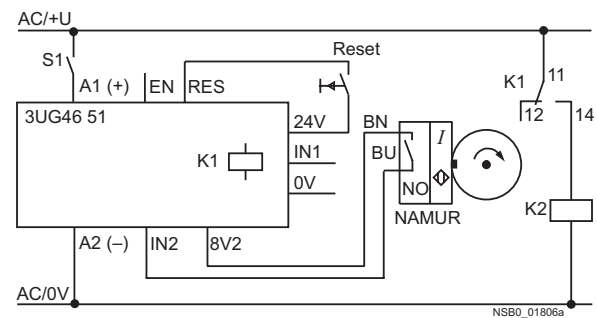

Circuit example with enable input

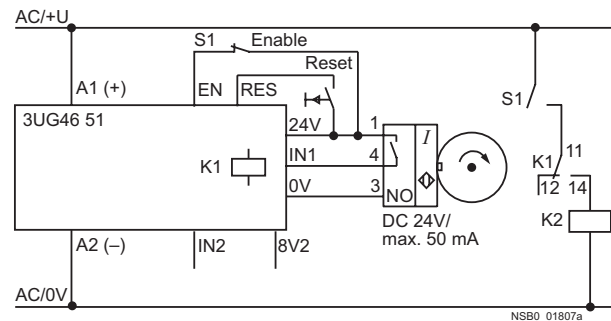

Position of the terminals

24V	IN1	0V
A1+	EN	RES
8V2	IN2	A2-
12	11	14

NSB0_01824

3TX0 interface relays are available in two basic versions. The 3TX7004/05 is just 6.2 mm wide: This series means that the interface relays take up a lot less space in the electrical cabinet. Then there is our 3TX7002/03 series: These devices are suitable for mounting in small electrical cabinets with a low depth and short distances between the mounting rails. Both series are available with an extensive range of input and output interfaces.

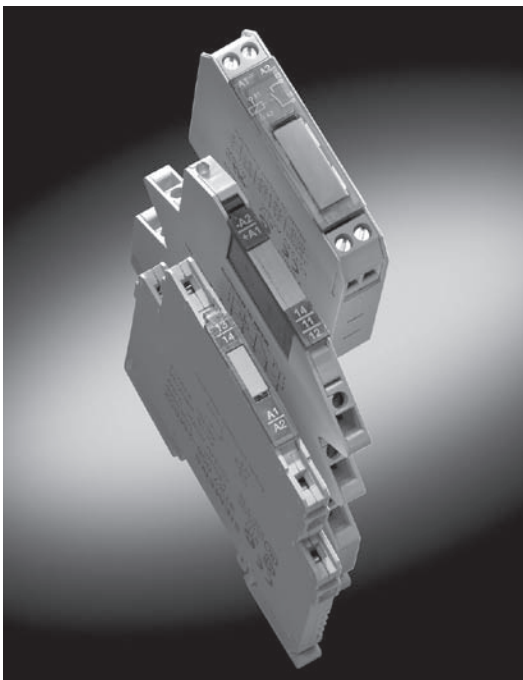

Your advantages: 3TX7002/03 and 3TX7004/05

- Operating range from 0.7 to 1.25 V_s at 24 V DC up to 60 °C
- Protective circuit is integrated in the input
- Connection comb and cable to connect voltages at the same potential
- Manual-0-automatic switch for easier commissioning

Your advantages: 3TX7014 and 3TX7015

- Plug-in relays that can be quickly replaced with preassembled wiring
- Conductors are introduced and clamped from the front – therefore shorter wiring times
- Tested, complete devices reduce installation times
- Individual relays are available as spare parts
- Relay version with hard-gold-plated contacts – therefore achieving a high contact reliability

Applications:

- Electrically isolation
- Voltage conversion – e.g. from 24 V DC to 230 V AC
- Signal amplification
- Contact multiplication
- General relay controls
- Overvoltage and EMC protection of controls

Engineering information:

When selecting the interface for rated control supply voltages of 110 V AC and 230 V AC, the maximum permissible cable length must be carefully observed. The special 3TX700- 05 relay can be used for longer cables.

Interface relays as input or output coupler

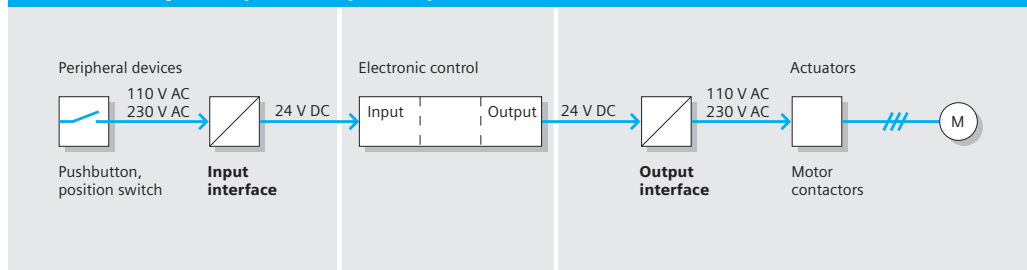

3TX70 interface relays

3TX701 Interface relay, plug-in						
Plug-in socket interface, complete with relay						
Contact	Rated control supply voltage V_s	Width	Hard-gold-plated	M-0-A switch	Order No.	List Price\$
1 NO	24 V DC	6.2 mm	–	–	3TX701□-1AM00	
1 CO	24 V DC	6.2 mm	–	–	3TX701□-1BM00	
	24 V AC/DC	6.2 mm	–	–	3TX701□-1BB00	
	115 V AC/DC	6.2 mm	–	–	3TX701□-1BE00	
	230 V AC/DC	6.2 mm	–	–	3TX701□-1BF00	
Plug-in socket interface relay, complete with relay and hard-gold-plated contacts						
1 CO	24 V DC	6.2 mm	yes	–	3TX701□-1BM02	
	24 V AC/DC	6.2 mm	yes	–	3TX701□-1BB02	
	115 V AC/DC	6.2 mm	yes	–	3TX701□-1BE02	
	230 V AC/DC	6.2 mm	yes	–	3TX701□-1BF02	
Accessories						
Connecting comb, 16 pin					3TX7014-7AA00	
Potential isolation plate					3TX7014-7CE00	

Screw Terminal 4

Spring-type Terminal 5

3TX700 relay interfaces, cannot be plugged-in						
3TX7004 05 – output interface with relay output						
Contact	Rated control supply voltage	Width	Hard-gold-plated	M-0-A switch	Order No.	List Price \$
1 CO	24 V AC/DC	6.2 mm	–	–	3TX700□-1LB00	
			yes	–	3TX700□-1LB02	
	230 V AC/DC	12.5 mm	–	yes	3TX7004-1BB10	
			6.2 mm	–	–	3TX700□-1LF00
		12.5 mm	–	–	3TX7004-1BF05 ¹⁾	
1 NO	24 V AC/DC	6.2 mm	–	–	3TX700□-1MB00	
	230 V AC/DC	6.2 mm	–	–	3TX700□-1MF00	
3TX7004 05 – input interface with relay output						
1 NO	230 V AC/DC	6.2 mm	yes	–	3TX700□-2MF02	
	110 V AC/DC	6.2 mm	yes	–	3TX7004-2ME02	
	24 V AC/DC	6.2 mm	yes	–	3TX700□-2MB02	

Screw Terminal 4

Spring-type Terminal 5

3TX7002 03 – for low heights between tiers – output interface with relay output						
Output	Voltage	Width	Hard-gold-plated		Order No.	List Price \$
1 NO	24 V AC/DC	11.5 mm	–		3TX700□-1AB00	
		11.5 mm	yes		3TX700□-1AB02	
1 CO	24 V AC/DC	17.5 mm	–		3TX700□-1BB00	
	230 V AC/DC	17.5 mm	–		3TX7002-1BF00	
2 NO	24 V AC/DC	22.5 mm	–		3TX700□-1CB00	
2 CO	24 V AC/DC	22.5 mm	yes		3TX700□-1FB02	
3TX7002 03 – input interface with relay output						
1 NO	230 V AC/DC	11.5 mm	–		3TX700□-2AF00	
	230 V AC/DC	11.5 mm	–		3TX7002-2AF05	
	110 V AC/DC	11.5 mm	–		3TX7002-2AE00	
	24 V AC/DC	11.5 mm	–		3TX7002-2AB00	
1 CO	230 V AC/DC	17.5 mm	yes		3TX7002-2BF02	

Accessories

Connecting cable with 24 connecting points for 3TX70					3TX7004-8BA00	
Connecting comb with 24 connecting points for 3TX7004, 6.2 mm wide					3TX7004-8AA00	

¹⁾ For longer cables up to 350 m

Screw Terminal 2

Spring-type Terminal 3

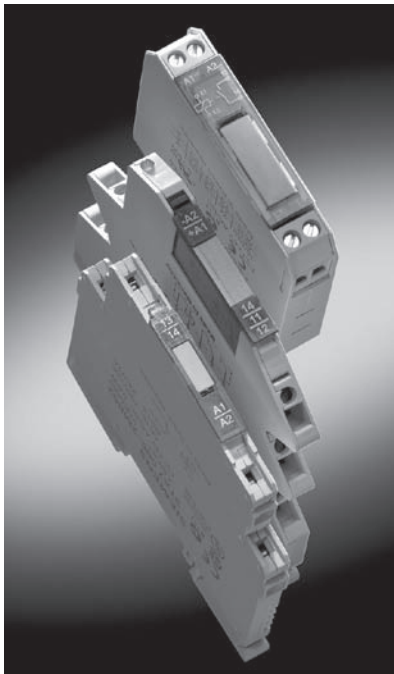

Interface modules are available either with relays or semiconductors. Semiconductor interfaces offer some significant advantages: The electronic components are extremely reliable and have an extremely long service life (refer to the diagram below). The input interface combines the best of both worlds – improved technical features and a lower price. When considering output interfaces, the question of “relay or semiconductor” needs to be taken into account as well as the making/breaking capacity and the number of operating cycles. If a relay has to be replaced just once during the complete lifetime of a machine, then a semiconductor interface will already have paid for itself.

Your advantages:

- Favorably priced and reliable: Input interfaces with semiconductor output
- Graduated series of output interfaces with semiconductors
- Extremely long electrical life
- Extremely high contact reliability
- High DC making/breaking capacity
- Short switching times

Applications:

- Providing electrical isolation, converting voltages
- Switching DC loads
- Switching capacitive loads
- High number of switching cycles
- Overvoltage and EMC protection of controls

Use of semiconductor interfaces

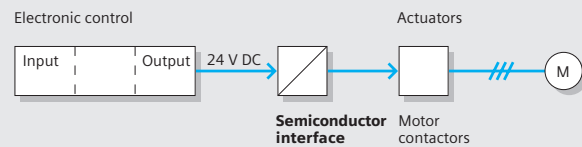

Comparison of lifetimes

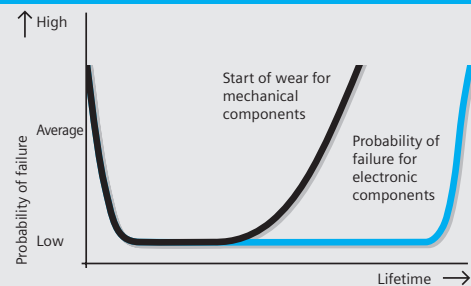

Electronic interface modules have a significantly higher lifetime than electromechanical devices.

Function Relays, Interfaces and Converters

Interface Relays – Narrow Design

SIRIUS
RELAYS

3TX70 semiconductor interfaces

3TX70 semiconductor interfaces

3TX7004/05 – the narrow space saver – output interfaces with semiconductor output, 1 NO contact

Control supply voltage	Width	Max. switching current	Switching voltage	Min. load current	Short-time load capacity	M-0-A switch	Order No.	List Price \$
24 V DC	6.2 mm	0.5 A	≤ 48 V DC	–	1.5 A/20 ms	–	3TX700□-3AB04	
	6.2 mm	1.5 A	≤ 30 V DC	–	Short-circuit proof	–	3TX700□-3PB54	
	12.5 mm	5 A	≤ 30 V DC	0.5 A	Short-circuit proof	–	3TX700□-3AC04	
	12.5 mm	5 A	≤ 30 V DC	0.5 A	Short-circuit proof	yes	3TX700□-3AC14	
	12.5 mm	2 A	24–250 V AC	0.05 A	100 A/20 ms	–	3TX700□-3AC03	
110–230 V AC	6.2 mm	3 A	≤ 30 V DC	–	Short-circuit proof	–	3TX700□-3PG74	

Input interfaces with semiconductor output, 1 NO contact

110–230 V AC	6.2 mm	0.1 A	≤ DC 30 V	–	0.2 A/3 ms	–	3TX700□-4PG24	
--------------	--------	-------	-----------	---	------------	---	---------------	--

Screw Terminal **4**

Spring-type Terminal **5**

3TX7002 – for low tier heights – output coupler with semiconductor output, one NO contact

Control supply voltage	Width	Max. switching current	Switching voltage	Min. load current	Short-time load capacity	Order No.	List Price \$
24 V DC	12.5 mm	1.8 A	48–264 V AC	0.06 A	20 A/20 ms	3TX7002-3AB00	
24 V DC	11.5 mm	1.5 A	≤ 60 V DC	–	4 A/0.2 ms	3TX7002-3AB01	

Input interfaces with semiconductor output, 1 NO contact

110–230 V AC	12.5 mm	0.1 A	≤ 60 V DC	–	1 A/20 ms	3TX7002-4AG00	
24 V AC/DC	12.5 mm	0.1 A	≤ 30 V DC	–	1 A/20 ms	3TX7002-4AB00	

Accessories

Connecting cable with 24 connecting points for 3TX70	3TX7004-8BA00	
Connecting comb with 24 connecting points for 3TX7004, 6.2 mm wide	3TX7004-8AA00	

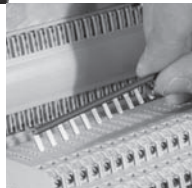
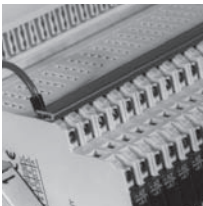

Using the accessories it is easy to insert a jumper between the same voltage levels.

General data			
Rated insulation voltage U_i (pollution degree 3)	V		300
Safe isolation acc. to DIN VDE 0106 Part 101 between coil and contacts	AC V		up to 300
Degree of protection	Connections Enclosure		IP 20 IP 30
Short-circuit protection (weld-free protection at $I_k \geq 1$ kA) Fuse links, utilisation category gL/gG	A		4
Permissible ambient temperature	in operation when stored	°C °C	-25 ... +60 -40 ... +80
Conductor cross-sections Screw terminals (for 3TX7 004): solid finely stranded with or without end sleeves Terminal screws Cage Clamp connections (for 3TX7 005): solid/finely stranded finely stranded with end sleeve	mm ² mm ² mm ² mm ²		1 x (0.25 ... 4) 1 x (0.5 ... 2.5) M 3 1 x (0.08 ... 2.5) 1 x (0.25 ... 1.5)
Control circuit			
Working range	at DC 17 to 40 V at $U_s =$ AC/DC 24 V at $U_s =$ AC/DC 110 and 230 V		- 0.7 to 1.25 x U_s 0.8 to 1.1 x U_s
Power consumption U_s			approx. 0.5 W/channel; 3TX7 00...05: 1 W for DC/6 VA for AC
Permissible residual current of the electronics (with 0 signal)	Overall width 6.2 mm Overall w. from 12.5 mm exception: 3TX7 00.-1LH00 3TX7 00.-1BF05	mA mA mA mA	$U_s = 24$ V; 2 $U_s > 24$ V; 0.5 2.5 1.5 5 ($U_s =$ AC 230 V) 0.5 ($U_s =$ DC 230 V)
Operating times at U_s	ON-delay OFF-delay	ms ms	< 8 < 15
Status indication			Yellow LED
Max. permissible cable lengths (min. cross-section: 0.75 mm ²)			3TX7 00 .-1 . F00 -2ME02 -2MF02 3TX7 00 .-1 . B . . -2MB02 3TX7 00 .-1 . H0 . 3TX7 00 .-1BF05
	AC DC	m m	40 2000 400 2000 on request 350 2000
Load side			
Rated operational current ¹⁾ Conventional thermal current I_{th} Rated operational current I_s acc. to utilisation category (DIN VDE 0660)	A A A		3TX7 00 .-1A/-1B/-1C/-1H/-1G 6 AC-15 DC-13 3 1.0 3 0.2 3 0.1
	at 24 V 110 V 230 V	A A A	2 1.0 2 0.2 2 0.1
Switching current with resistive load acc. to DIN VDE 0435 (relay standard) and DIN VDE 0660	A A A		AC-12 DC-12 AC-12 DC-12 6 6 6 6 6 0.3 6 0.3 6 0.2 6 0.2
Min. contact loading for 3TX7 00 .-1 . . . 0/5			AC/DC 17 V, 5 mA AC/DC 17 V, 5 mA
Min. contact loading for 3TX7 00 .- . . . 02 (hard gold-plated)			AC/DC 1 V, 0.1 mA AC/DC 1 V, 0.1 mA
Output limit for hard gold-plating			30 V/20 mA 30 V/20 mA
Switching voltage			AC/DC 17 to 250 V AC/DC 17 to 250 V
Mechanical endurance			20 x 10 ⁶ operating cycles 20 x 10 ⁶ operating cycles
Electrical endurance at I_s			1 x 10 ⁵ operating cycles 0.5 x 10 ⁵ operating cycles
Operating frequency	1/h		5000 operating cycles 5000 operating cycles

Note: The service life of the coupling relays can be increased by connecting inductive loads.

1) Capacitive loads can result in micro-welding at the contacts.

Function Relays, Interfaces and Converters

Coupling Relays and Interfaces

SIRIUS
RELAYS

3TX7 004/005 relay and semiconductor interfaces

Technical data

General data

Rated insulation voltage U_i (pollution degree 3)	V	300
Safe isolation acc. to DIN VDE 0884	V	up ... 300
Permissible ambient temperature	in operation °C when stored °C	-20 ... +60 -40 ... +80
Conductor cross-sections		
Screw terminals (for 3TX7 004):		
solid	mm ²	1 x (0.25 ... 4)
finely stranded with or without end sleeves	mm ²	1 x (0.5 ... 2.5)
Terminal screws		M 3
Cage Clamp connections (for 3TX7 005):		
solid/finely stranded	mm ²	1 x (0.08 ... 2.5)
finely stranded with end sleeve	mm ²	1 x (0.25 ... 2.5)

Type	3TX7 004-/ 3TX7 005-	3AB04/ 4AB04	3AC.4	3AC03	3PB54	4PG24
------	-------------------------	-----------------	-------	-------	-------	-------

Control circuit

Working range	V	11 ... 30 DC	11 ... 30 DC	11 ... 30 DC	11 ... 30 DC	110 ... 230 AC/DC
Power consumption	at 24 V DC W AC 230 V W	≤ 0.5 –	≤ 0.5 –	≤ 0.25 –	≤ 0.2 –	– ≤ 1.5
Release voltage	V	6	5	6	9	20
Permissible residual current of the electronics (with 0 signal)	mA	2.3	2.6	1.5	1.5	0.4
Operating times	ON-delay ms OFF-delay ms	2.5 8	0.3 4	10 10	0.3 0.3	1 6
Status indication		Yellow LED	Yellow LED	Yellow LED	Yellow LED	Yellow LED
Max. permissible cable lengths (min. cross-section: 0.75 mm ²)	m	1700	2000	2000	2000	40

Type	3TX7 004-/ 3TX7 005-	3P.74	3PB41	3RB43	
Working range	V	110 ... 230 AC/DC	11 ... 30 DC	18 ... 30 DC	
Power consumption	at 24 V DC W AC 230 V W	– ≤ 1.5	≤ 0.5 –	≤ 0.3 –	
Release voltage	V	25	5	12	
Permissible residual current of the electronics (with 0 signal)	mA	1	1.5	4	
Operating times	ON-delay ms OFF-delay ms	1.5 75	4 6	0.2 10	
Status indication		Yellow LED	Yellow LED	Yellow LED	
Max. permissible cable lengths (min. cross-section: 0.75 mm ²)	m	40	2000	2000	

Technical data

Type	3TX7 004-/ 3TX7 005-	3AB04/ 4AB04	3AC.4	3AC03	3PB54
------	-------------------------	-----------------	-------	-------	-------

Load side					
Switching voltage	V	≤ DC 48	≤ DC 30	AC 24 ... 250	≤ DC 30
Switching current	A	0.5	5	2	1.5
Short-time load rating	A ms	1.5 20	Short-circuit proof 1)	100 20	Short-circuit proof 2)
Contacts		1 NO transistor	1 NO transistor	1 NO Triac	1 NO transistor
Minimum load current	mA	–	500 ³⁾	50	–
Conductive voltage drop	V	≤ 1	≤ 0.5	≤ 1.6	≤ 0.5
Residual current of the electronics (with 0 signal)	mA	< 0.1	< 0.1	< 6	< 0.1
Operating frequency with resistive load	Hz	50	50	1	500

Type	3TX7 004-/ 3TX7 005-	3P.74	3PB41	3RB43	4P.24
Switching voltage	V	≤ DC 30	≤ DC 200	AC 24 ... 250	≤ DC 30
Switching current	A	3	0.75	0.5	0.1
Short-time load rating	A ms	Short-circuit proof 2)	3 2	0.8 3	0.2 3
Contacts		1 NO transistor	1 NO transistor	1 NO Triac	1 NO transistor
Minimum load current	mA	–	–	10	–
Conductive voltage drop	V	≤ 0.5	≤ 2	≤ 1.5	≤ 1.5
Residual current of the electronics (with 0 signal)	mA	≤ 0.1	≤ 0.1	≤ 1	≤ 0.1
Operating frequency with resistive load	Hz	10	50	50	500

1) The semiconductor output switches off in the case of a short-circuit or overload. Before the device can be operated again, it must be disconnected briefly from the supply voltage.

2) The current is limited by the semiconductor output in the case of a short-circuit or overload.

3) Below the minimum load current, the built-in semiconductor detects a wire-break in the load circuit. To reset this, the control circuit must be briefly deactivated.

3TX7 004/005 relay and semiconductor interfaces

Application

DC operation

DIN VDE 0110 Part 1,
DIN VDE 0435, DIN VDE 0660
and EN 50 005
Optocoupler: DIN VDE 0884
DIN VDE 0411 Part 500,
IEC 61 131-2 (programmable
logic controllers)

In the case of coupling elements in double-tier design, the terminals are arranged in two tiers and the devices are extremely narrow. Connection technique: Screw terminal or Cage Clamp. Versions with Manual-O-Automatic switches are available for test purposes. The input and output coupling devices differ with regard to the location of the connections and LEDs. For equipment identification purposes, each coupling device has a blank legend plate.

Similar to the technical data of the solid-state systems, the devices have a low power consumption.

Construction

Mounting instructions

Snap-on mounting onto horizontal and vertical standard rails is possible. For a vertical rail and closely mounted devices, the permissible ambient temperature is $T_v = 40^\circ\text{C}$. Any service position is possible.

When the permissible upper limit of rated control supply voltage is fully exploited as well as the highest permissible ambient temperature, and the device operates with a continuous 24-hour (100%) ON period, it is recommended that no devices of a similar type or other devices with a high external temperature are mounted adjacently without appropriate gaps; otherwise the service life of the coupler can be reduced.

A gap of $> 10\text{mm}$ on the left-hand and right-hand sides of the device reduces the risk of premature failure under these conditions of application.

Optocouplers switch by means of semiconductors. These are not subject to wear, so welding of contacts is not possible.

The 6.2 mm wide optocouplers have an opening on the right-hand side of the enclosure. They can be – like the relay couplers – mounted in a row without gaps.

Functions

Surge suppression

The coupling devices are tested with 1×10^5 operating cycles in AC-15 operation with the values specified in the technical data. The service life of the relay connector can be increased by connecting inductive loads.

Note

When capacitive loads are switched in the absence of components (series resistors) that limit the brief peak currents, this can cause micro welding of the relay contacts.

To guarantee shock hazard protection in modules of the 6.2 mm series with enclosure opening (e. g. 3TX7 004-3AB04), the individual module or the final module in a row must be fitted with an end plate.

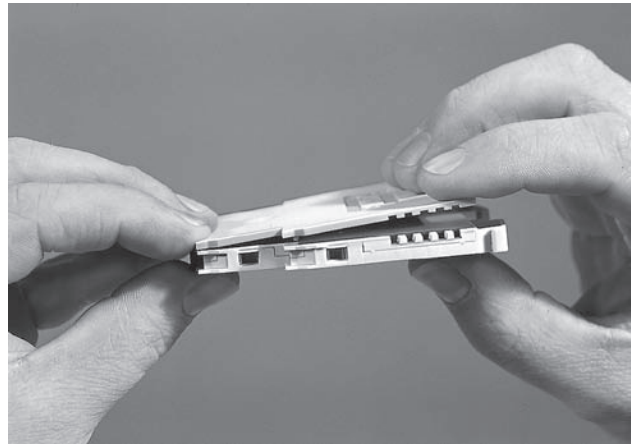

Connecting a cable to the Cage Clamp

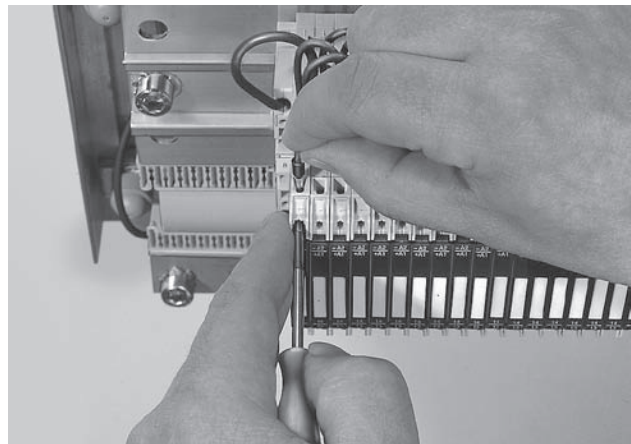

Circuit diagrams

Terminal diagrams

Relay interfaces

Terminal designations according to EN 50 005

3TX7 002- . A . 00
-1AB02
-2AF05

-1B . 00

-1CB00

-1FB02

-2BF02

3TX7 003- . A . 00

-1B . 00

-1CB00

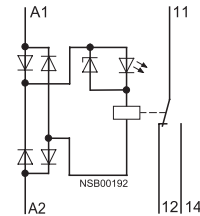
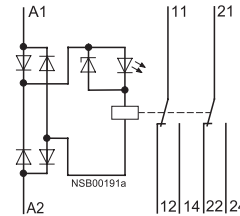
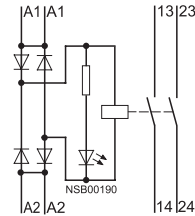
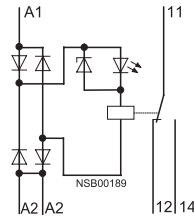
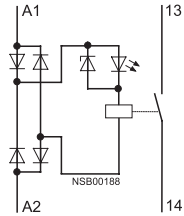

Semiconductor interfaces

Terminal designations according to EN 50 005

3TX7 002-3AB00

-3AB01

-4AB00

-4AG00

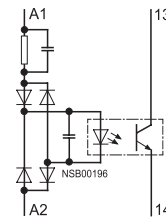
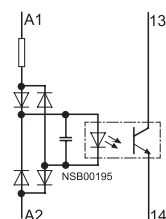
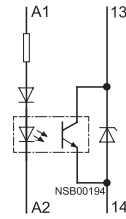
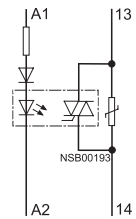

Position of terminals

Relay interfaces

Output interfaces

3TX7 002-1AB0 .
3TX7 003-1AB00

-1B . 00
-1B . 00

-1CB00
-1CB00

-1FB02

Input interfaces

3TX7 002-2A . 0 .
3TX7 003-2A . 0 .

-2BF02

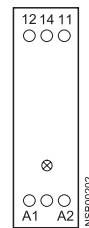
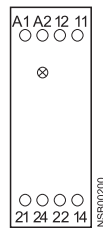
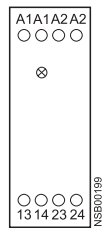
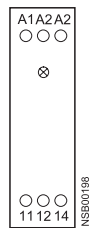
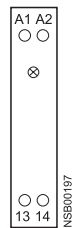

Semiconductor interfaces

Output interfaces

3TX7 002-3AB0 .

Input interfaces

3TX7 002-4A . 0 .



3TX70 relay and semiconductor interfaces

Circuit diagrams

Terminal diagrams

Relay interfaces

• Output interfaces

3TX7 00 .-1M . 00

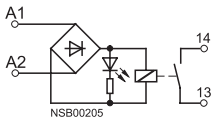

3TX7 00 .-1AB10

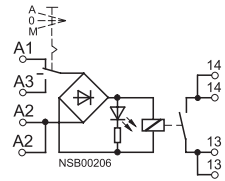

3TX7 00 .-1BB00
-1BF05

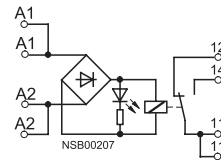

3TX7 00 .-1L . 0.

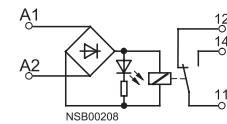

3TX7 00 .-1BB10

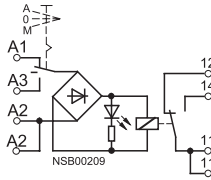

3TX7 00 .-1CB00

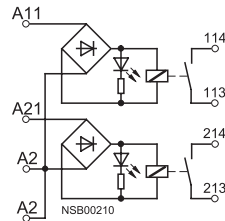

3TX7 00 .-1HB00

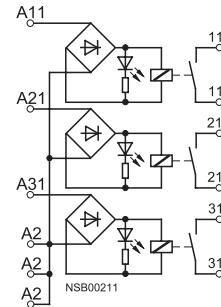

3TX7 00 .-1GB00

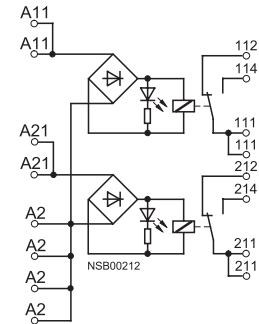

• Input interfaces

3TX7 00 .-2M . 02

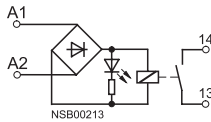

• Output interfaces

3TX7 00 .-3AB04
-3PB41

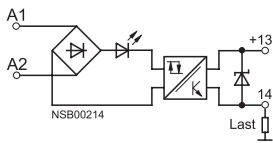

3TX7 00 .-3PB54
-3PG74

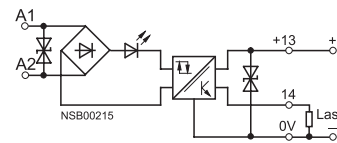

3TX7 00 .-3AC04

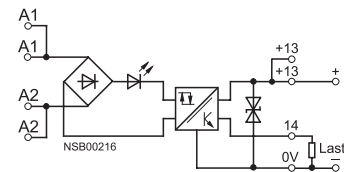

3TX7 00 .-3AC14

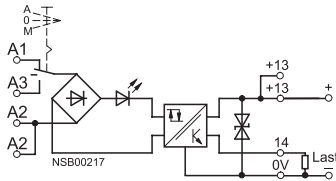

3TX7 00 .-3AC03

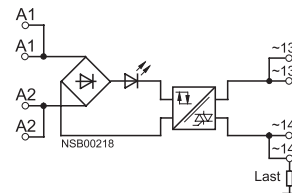

3TX7 00 .-3RB43

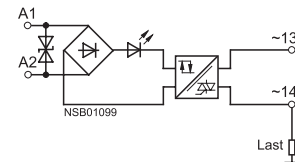

• Input interfaces

3TX7 00 .-4AB04
-4P . 24

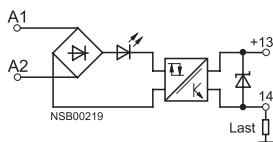

A = Automatic
0 = Neutral
M = Manual

Circuit diagrams

Position of terminals

Relay interfaces

• Output interfaces

3TX7 004
-1M . 00



-1L . 0 .



-1AB10

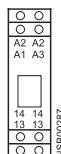

-1B . 0 .

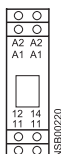

-1BB10

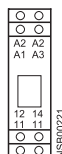

-1CB00

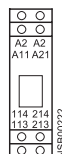

-1HB00

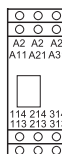

-1GB00



• Input interfaces

3TX7 004-2M...



3TX7 005
-1M . 00



-1L . 0 .



-1AB10

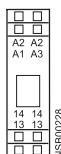

-1BB00

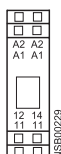

-1BB10

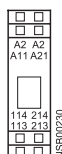

-1CB00

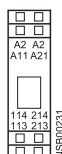

-1HB00



-1GB00



3TX7 005-2M...



Semiconductor interfaces

• Output interfaces

3TX7 004
-3AB04,
-3PB41

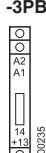

-3PB54,
-3PG74

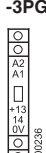

-3AC04

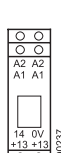

-3AC14

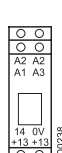

-3AC03

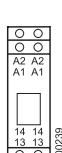

-3RB43

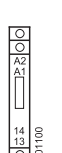

• Input interfaces

3TX7 004-4AB04
-4P . 24



3TX7 005
-3AB04,
-3PB41

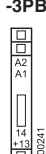

-3PB54,
-3PG74



-3AC04

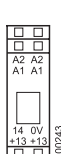

-3AC14

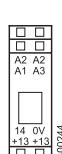

-3AC03

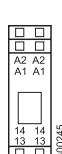

-3RB43

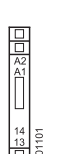

3TX7 005-4AB04
-4P . 24



3TX70 relay and semiconductor interfaces

Dimension drawings

3TX7 002, 3TX7 003 interfaces in modular terminal block design

3TX7 00 .-1AB . . ,
3TX7 00 .-2A . . . ,
3TX7 002-3AB01

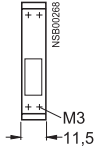

3TX7 002-3AB00,
3TX7 002-4A . . .

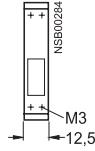

3TX7 00 .-1BB00,
3TX7 00 .-1BF00,
3TX7 002-2BF02

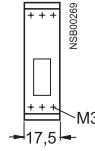

3TX7 00 .-1CB00,
3TX7 002-1BF02

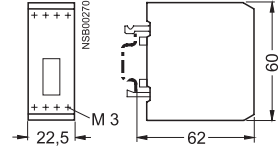

3TX7 004, 3TX7 005 interfaces in double-tier design

Relay coupling devices
3TX7 00 .-1MB00,
3TX7 00 .-1MF00,
3TX7 00 .-1L . 0 . . ,
3TX7 00 .-2M . . .

Relay coupling devices
3TX7 00 .-1AB10,
3TX7 00 .-1BB00,
3TX7 00 .-1BB10,
3TX7 00 .-1CB00,
3TX7 00 .-1BF05

Relay interfaces
3TX7 00 .-1HB00

Relay interfaces
3TX7 00 .-1GB00

Semiconductor interfaces

3TX7 00 .-3AB04,
3TX7 00 .-4AB04,
3TX7 00 .-3PB . . ,
3TX7 00 .-3PG74,
3TX7 00 .-3RB43,
3TX7 00 .-4P . 24

Semiconductor interfaces

3TX7 00 .-3AC04,
3TX7 00 .-3AC14,
3TX7 00 .-3AC03

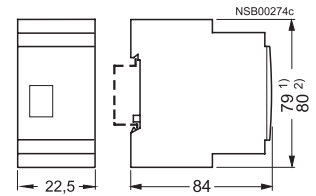
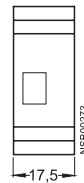
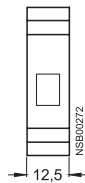
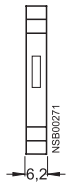

1) Dimension for 3TX7 004 interfaces (screw connections).

2) Dimension for 3TX7 005 interfaces (Cage Clamp connections).

The new 3RS18 interface relays set new standards: They have a wide-range voltage extending from 24 V AC DC to 240 V. This makes them absolutely unique in the interface market. All of these devices are accommodated in a well-proven, rugged 22.5 mm wide enclosure. Relays with 1, 2 and 3 changeover contacts are available in both screw and Cage Clamp terminal versions. Not only this, also in combination and wide-range voltage with hard-gold-plated contacts for an especially high contact reliability – even at low current levels. Thanks to the well-proven, rugged enclosure, you can enjoy the benefits of user-friendly connection systems, including Cage Clamp terminals – just the same as delete our time relays. 2 conductors can be connected at each terminal point.

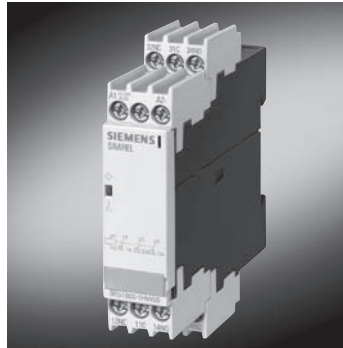

Your advantages:

- New, worldwide: One device for all voltages
- Lower costs due to fewer versions
- User-friendly wiring
- Especially high contact reliability even at low currents

Applications:

- Everywhere that contacts which are electronics-compatible are required and where devices with wide-range voltage are used
- Thanks to the hard-gold-plated contacts, predestined for PLC I/O

3RS18 interface relays in a rugged, industrial enclosure 22.5 mm wide			
Rated control supply voltage V_s	Contact versions	Order No.	List Price \$
50 60 Hz			
Wide-range voltage 24–240 V AC/DC	2 CO	3RS18 00-□BW00	
	3 CO	3RS18 00-□HW00	
	3 CO hard-gold-plated	3RS18 00-□HW01	
Combination voltage 24 V AC/DC and 110–120 V AC	1 CO	3RS18 00-□AQ00	
	2 CO	3RS18 00-□BQ00	
	3 CO	3RS18 00-□HQ00	
	3 CO hard-gold-plated	3RS18 00-□HQ01	
24 V AC/DC and 220–240 V AC	1 CO	3RS18 00-□AP00	
	2 CO	3RS18 00-□BP00	
	3 CO	3RS18 00-□HP00	
	3 CO hard-gold-plated	3RS18 00-□HP01	

Screw Terminal 1

Spring-type Terminal 2

Overview

In automation and closed-loop control, working with analog signals is unavoidable. Interfaces of 0 to 10 V and 0/4 to 20 mA have become established in this field. Interface converters load the coupling function for analog signals on the input side as well as on the output side. They are indispensable

where analog values are processed with electronic controls. In the harsh industrial environment, signals often have to be transferred over large distances. Electrical isolation is necessary due to the various different power supplies. Potential differences and losses due to cable resistance must be

prevented. Electromagnetic disturbances and overvoltages can affect the signals especially at the input end and even destroy the analog modules. With regard to the output, short-circuit protection is of particular importance. The devices are EMC-tested acc. to EN 50081 (emission)

and EN 61000-6-2 (immunity). The analog signals correspond to IEC 60 381-1/2.

Application

Converters are used in analog signal processing for:

- Electrical isolation
- Conversion of normalised and non-normalised signals
- Amplification, impedance adjustment
- Conversion to frequency for processing by a digital input
- Overvoltage and EMC protection
- Short-circuit protection of the outputs

Example for application: Interface converter in analog signal evaluation

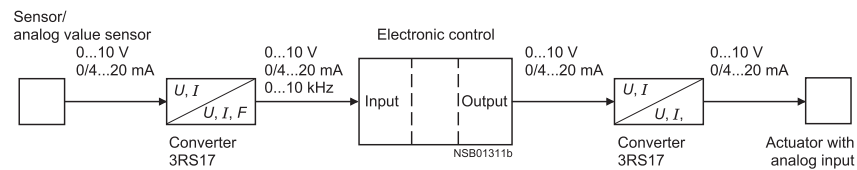

Selection and ordering data

Screw and Spring-type Terminal Connection

All converters with the exception of the passive individual interface converters are equipped with a yellow LED for indication of "Voltage applied".

Input	Output	Width	Supply voltage	Electrical isolation	Screw terminals Order No.	Spring-type terminals Order No.	List Price \$	Weight approx. kg
		mm	V					

Individual interface converters, active



0 ... 10 V	0 ... 10 V	6.2	AC/DC 24	2 way 3 way	3RS17 00-1AD00 3RS17 00-1AE00	3RS17 00-2AD00 3RS17 00-2AE00		0.03
0 ... 10 V	0 ... 20 mA	6.2	AC/DC 24	2 way 3 way	3RS17 00-1CD00 3RS17 00-1CE00	3RS17 00-2CD00 3RS17 00-2CE00		0.03
0 ... 10 V	4 ... 20 mA	6.2	AC/DC 24	2 way 3 way	3RS17 00-1DD00 3RS17 00-1DE00	3RS17 00-2DD00 3RS17 00-2DE00		0.03
0 ... 20 mA	0 ... 10 V	6.2	AC/DC 24	2 way 3 way	3RS17 02-1AD00 3RS17 02-1AE00	3RS17 02-2AD00 3RS17 02-2AE00		0.03
0 ... 20 mA	0 ... 20 mA	6.2	AC/DC 24	2 way 3 way	3RS17 02-1CD00 3RS17 02-1CE00	3RS17 02-2CD00 3RS17 02-2CE00		0.03
0 ... 20 mA	4 ... 20 mA	6.2	AC/DC 24	2 way 3 way	3RS17 02-1DD00 3RS17 02-1DE00	3RS17 02-2DD00 3RS17 02-2DE00		0.03
4 ... 20 mA	0 ... 10 V	6.2	AC/DC 24	2 way 3 way	3RS17 03-1AD00 3RS17 03-1AE00	3RS17 03-2AD00 3RS17 03-2AE00		0.03
4 ... 20 mA	0 ... 20 mA	6.2	AC/DC 24	2 way 3 way	3RS17 03-1CD00 3RS17 03-1CE00	3RS17 03-2CD00 3RS17 03-2CE00		0.03
4 ... 20 mA	4 ... 20 mA	6.2	AC/DC 24	2 way 3 way	3RS17 03-1DD00 3RS17 03-1DE00	3RS17 03-2DD00 3RS17 03-2DE00		0.03

Multi-range converters, selectable



0 ... 10 V	0 ... 10 V	6.2	AC/DC 24	2 way	3RS17 05-1FD00	3RS17 05-2FD00		0.03
0 ... 20 mA	0 ... 20 mA	17.5	AC/DC 24	3 way	3RS17 05-1FW00	3RS17 05-2FW00		0.1
4 ... 20 mA selectable	4 ... 20 mA selectable		AC/DC 24 to 240					
0 ... 10 V	0 ... 50 Hz	6.2	AC/DC 24	2 way	3RS17 05-1KD00	3RS17 05-2KD00		0.1
0 ... 20 mA	0 ... 100 Hz	17.5	AC/DC 24	3 way	3RS17 05-1KW00	3RS17 05-2KW00		0.1
4 ... 20 mA selectable	0 ... 1 kHz selectable		AC/DC 24 to 240					

Universal converters, selectable



0 ... 60 mV	0 ... 10 V	17.5	AC/DC 24	2 way	3RS17 06-1FD00	3RS17 06-2FD00		0.1
0 ... 100 mV	0 ... 20 mA			3 way	3RS17 06-1FE00	3RS17 06-2FE00		0.1
0 ... 300 mV	4 ... 20 mA		AC/DC 24	3 way	3RS17 06-1FW00	3RS17 06-2FW00		0.1
0 ... 500 mV selectable	selectable		AC/DC 24 to 240					
0 ... 1 V								
0 ... 2 V	0 ... 10 mA							
0 ... 5 V	0 ... 20 mA							
0 ... 10 V	4 ... 20 mA							
0 ... 20 V	± 5 mA							
2 ... 10 V	± 20 mA							
0 ... 5 mA	selectable							

Multi-range converters, selectable, with Manual/Automatic switch and setting potentiometer as manual analog signal encoder



0 ... 10 V	0 ... 10 V	17.5	AC/DC 24	2 way	3RS17 25-1FD00	3RS17 25-2FD00		0.1
0 ... 20 mA	0 ... 20 mA		AC/DC 24	3 way	3RS17 25-1FW00	3RS17 25-2FW00		0.1
4 ... 20 mA selectable	4 ... 20 mA selectable		AC/DC 24 to 240					

Input	Output	Width	Number of channels	Electrical isolation	Screw terminals Order No.	Spring-type terminals Order No.	List Price \$	Weight approx. kg
		mm						

Individual interface converters, passive



0/4 ... 20 mA	0/4 ... 20 mA	6.2	1-channel	2 way	3RS17 20-1ET00	3RS17 20-2ET00		0.05
0/4 ... 20 mA	0/4 ... 20 mA	12.5	1-channel	2 way	3RS17 21-1ET00	3RS17 21-2ET00		0.05
0/4 ... 20 mA	0/4 ... 20 mA	12.5	2-channel	2 way	3RS17 22-1ET00	3RS17 22-2ET00		0.05

3RS17

Technical data

General data

Type		AC/DC 24 V	AC/DC 24 to 240 V
Supply voltage range		DC: 0.7 to 1.25 U_n AC: 0.8 to 1.2 U_n	DC: 0.7 to 1.1 U_n AC: 0.8 to 1.1 U_n
Rated power (own requirements)	W	Typically 0.3	Typically 0.75
Electrical isolation input/output		Active disconnecter: 1500 V, 50 Hz, 1 min Passive disconnecter: 500 V, 50 Hz, 1 min	4000 V, 50 Hz, 1 min
Rated insulation voltage Pollution degree 2, overvoltage category III acc. to DIN VDE 0110	V	50	300
Ambient temperature	for operation for storage	°C °C	- 20 ... + 60 - 40 ... + 85
Conductor cross-sections			
Screw connections			
solid	mm ²	1 x (0.25 ... 4)	
finely stranded with or without end sleeves	mm ²	1 x (0.5 ... 2.5)	
Terminal screws		M 3	
Cage Clamp terminals			
solid/finely stranded	mm ²	1 x (0.08 ... 2.5)	
finely stranded with end sleeve	mm ²	1 x (0.25 ... 1.5)	
Enclosure degree of protection	IEC 529	IP 30	
Terminal degree of protection	IEC 529	IP 20	
Permissible mounting position		any	
Mounting onto standard rails	EN 50 022	mm	35
Vibration performance	IEC 68-2-6		10–55 Hz/0.35 mm
Shock resistance	IEC 68-2-27		15 g/11 ms

Input

		Voltage inputs	Current inputs active	Current inputs passive
Input impedance		330 kΩ	100 Ω	–
Max. input voltage	AC/DC V	30	30	–
Response current	μA	–	–	100/250 (6.2 mm overall width)
Voltage drop		–	–	2.7 V at 20 mA

Output

		0 to 10 V	0/4 to 20 mA active	0 to 20 mA passive	Frequency
Output impedance	Ω	55	–	–	–
Max. output load	Ω	–	400	1000 at 20 mA 400 at 20 mA (6.2 mm overall width)	2400
Max. output current	mA	21	–	–	10
Short-circuit current	mA	40	–	Corresponds to the input current	15
Protection of the outputs		Short-circuit proof	Short-circuit proof	Short-circuit proof	Short-circuit proof
Max. overvoltage at output	AC/DC V	30	30	–	30

Accuracy

		Active disconnecter (U, I)	Active disconnecter (frequency)	Passive disconnecter
Total error at 23 °C	%	0.1	0.1	–
Linearity error	%	0.02	0.02	–
Deviation due to ambient temperature		0 to 10 V: 1.5 mV/K 0/4 to 20 mA: 3 μA/K	0 to 50 Hz: 7.5 mHz/K 0 to 100 Hz: 15 mHz/K 0 to 1 KHz: 0.15 Hz/K 0 to 10 KHz: 1.5 Hz/K	Load < 600 Ω: < 50 ppm/K from measured value Load < = 600 Ω: < 175 ppm/K from measured value
Transmission error	%	–	–	0.1
Load error from measured value		–	–	0.06 %/100 Ω
Limit frequency 3 dB	Hz	30	30	50
Rise time (10 to 90%)	ms	10	10 + 1 periods	–
Settling time to 1% accuracy, typically	ms	30	30 + 1 periods	–
Residual ripple	mV _{rms}	< 5	–	< 8

Unless stated otherwise, the accuracy is specified with reference to the upper range limit

Configuration

Active interface converters

Active interface converters offer the widest application flexibility due to the use of an external supply voltage. Project engineering with active interface converters is easy, because

input and output resistances and voltage drops are balanced by the auxiliary power. They provide pure electrical isolation as well as conversion between the different signal

types or amplification. The loading on the encoder is negligible.

Passive interface converters

Passive interface converters do not require an external supply voltage. This advantage can only be utilised in the case of current signals that are transferred 1:1. Amplification or

conversion is not possible. The converters are used for clear electrical isolation of signals and for protecting the inputs and outputs. Passive disconnectors do not operate reac-

tion free, i.e. any load on the output affects the input signal to the same degree. When the passive converter is used, an analysis of the output power of the encoder and the input

resistance of the analog input must be performed. For pure currentis being used more and more.

Calculation aid for passive converters

⚠ Important:

When passive disconnectors are used, it is important to note that:

The current-driving voltage of the measuring transmitter U_E must be sufficient to drive the maximum current of 20 mA

through the passive disconnector with a voltage drop of $U_V = 2.7\text{ V}$ and the resistive load R_B .

This means that:

$$U_B \geq U_E = 2.7\text{ V} + 20\text{ mA} \times R_B$$

Voltage splitting with passive disconnectors

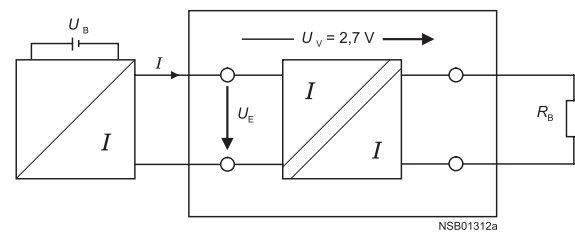

The following diagram shows the input voltage U_E as a function of the resistive load R_B taking into account the voltage drop U_V . If the resistive load is known, the minimum voltage that the current source has to produce in order to drive the maximum current of 20 mA via the passive disconnector and resistive load can be read off the Y-axis.

Input voltage

as a function of resistive load at $I_A = 20\text{ mA}$

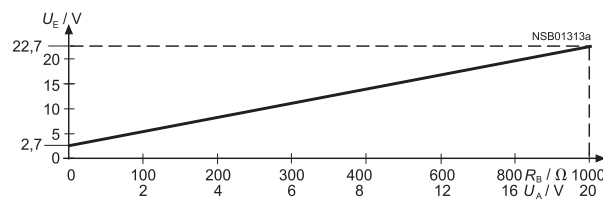

Current-carrying capacity of the outputs

A maximum output load is specified in the case of current signals. This resistance value specifies the maximum input resistance for the subsequent device for which the output of the converter is adequate.

For voltage signals, the maximum current that can be drawn from the output is the decisive factor.

2-way isolation

In the case of 2-way isolation, the input is electrically isolated from the output. The "zero potential" for the supply voltage is the same as that on which the analog output signal is referenced.

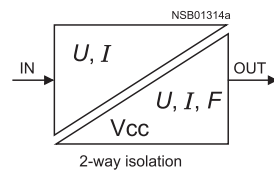

3-way isolation

In the case of 3-way isolation, each circuit is electrically isolated from the others, i.e. the input, output and supply voltage have no common potential.

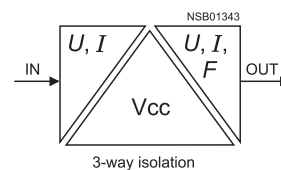

3RS17

Circuit diagrams

3RS17 00-..D..
3RS17 02-..D..
3RS17 03-..D..
3RS17 05-..D..

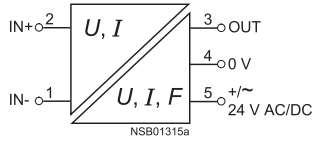

3RS17 06-..FD00

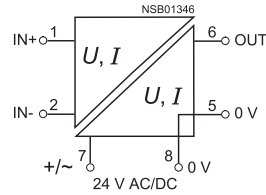

3RS17 06-..FE00

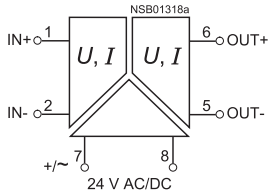

3RS17 0-..W00

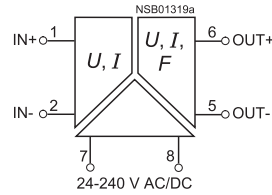

3RS17 25-..FD00

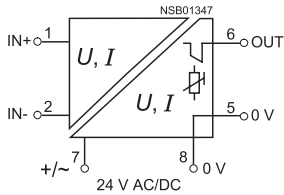

3RS17 25-..FW00

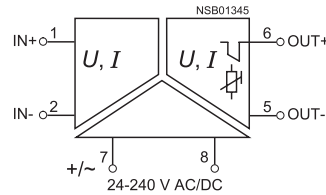

3RS17 20-..ET00

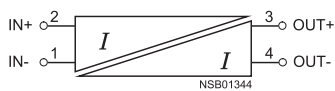

3RS17 21-..ET00

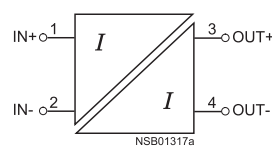

3RS17 22-..ET00

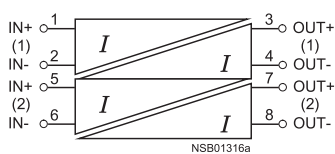

Dimension drawings

6.2 mm type:

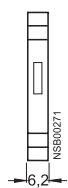

12.5 mm type:

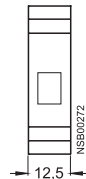

17.5 mm type:

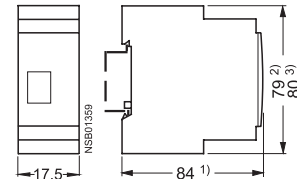

- 1) Overall depth for 3RS17 25 is approx. 90 mm.
- 2) Dimension for screw connection.
- 3) Dimension for Cage Clamp connection.

Overview

Version

The 3TG10 contactors with 4 main contacts are available with screw-type terminals or with 6.3 mm to 0.8 mm tab connectors. The designs with screw-type terminals are suitable for use in any climate and safe from touch to DIN VDE 0106 Part 100.

The 3TG10 contactors have a compact design. Their overall width is 36 mm.

Application

They are suitable for use in household appliances as well as for distribution boards in offices and residential buildings, owing to their hum-free construction. They can further be used in all areas where there is only a limited amount of space available, e.g. in air conditioners, heating systems, pumps and fans - basically in all simple electrical controls.

AC and DC operation

EN 60 947-4-1
(VDE 0660 Part 102).

Surge suppression

The 3TG10 contactors are fitted with an integrated protective circuit for damping opening surges.

Overload and short-circuit protection

The 3UA7 overload relay can be used for overload protection (see NS E catalogue, available in German). This applies both for contactor mounting and for mounting as a single unit.

The data for short-circuit protection of the contactors without using an overload relay are provided in the technical data.

Selection and ordering data

Ratings Utilization category			Main contacts	Rated control supply voltage U_c	Order No.	List Price \$	Weight approx.	Pack
AC-1 maximum resistive load	Horsepower ratings of three-phase loads at 50 Hz 400 V	AC-3 maximum inductive current	Design				kg	Units
A	kW	A	NO NC					

With screw connections, 4-pin for screwing and snapping onto 35 mm standard mounting rail · hum-free

• AC operation

	3TG10 ...0	20	5	8.4	4 -	230 V, 45–450 Hz 110 V, 45–450 Hz 24 V, 45–450 Hz	3TG10 10-0AL2 3TG10 10-0AG2 3TG10 10-0AC2	0.15	10
					3 1	230 V, 45–450 Hz 110 V, 45–450 Hz 24 V, 45–450 Hz	3TG10 01-0AL2 3TG10 01-0AG2 3TG10 01-0AC2	0.15	10

• DC operation

	20	5	8.4	4 -	DC 24 V	3TG10 10-0BB4	0.15	10
				3 1	DC 24 V	3TG10 01-0BB4		

With tab connectors 6.3 x 0.8 mm, 4-pin for screwing and snapping onto 35 mm standard mounting rail · hum-free

• AC operation

	3TG10 ...-1	16	5	8.4	4 -	230 V, 45–450 Hz 110 V, 45–450 Hz 24 V, 45–450 Hz	3TG10 10-1AL2 3TG10 10-1AG2 3TG10 10-1AC2	0.14	10
					3 1	230 V, 45–450 Hz 110 V, 45–450 Hz 24 V, 45–450 Hz	3TG10 01-1AL2 3TG10 01-1AG2 3TG10 01-1AC2	0.14	10

• DC operation

	16	5	8.4	4 -	DC 24 V	3TG10 10-1BB4	0.14	10
				3 1	DC 24 V	3TG10 01-1BB4		

1) The links for paralleling can be reduced by one pole. The rated operational currents are valid for each pole. The links for paralleling are insulated.

Function Relays, Interfaces and Converters

Coupling Relays and Interfaces

SIRIUS
RELAYS

3TG10 power relays

Technical data

General data

Mechanical endurance	operating cycles			3 mill.
Electrical endurance at I_e	operating cycles	AC-1 AC-3		0.1 million 0.4 million
Rated insulation voltage U_i (pollution degree 3)		V		400
Rated impulse withstand voltage U_{imp}		kV		4
Safe isolation acc. to DIN VDE 0106 Part 101 and A1 (draft 2/89) between coil and contacts		V		up to 300
Permissible ambient temperature	in operation ¹⁾ when stored	°C °C		-25 ... +55 -50 ... +80
Degree of protection acc. to IEC 60 947-1 and IEC 60 529 (VDE 0470 Part 1)				IP 00, coil system IP 20
Power consumption of the coils (with coil in cold state and $1.0 \times U_s$)	AC operation 45 – 450 Hz p.f. DC operation	VA W		4.4 0.9 (hum-free) 4
Coil voltage tolerance				0.85 to $1.1 \times U_s$
Operating times (break-time = opening time + arcing time)				AC operation DC operation
	Closing	closing time opening time	NO ms NC ms	10 ... 50 5 ... 45
	Opening	opening time closing time	NO ms NC ms	20 ... 30 20 ... 30
	Arcing time		ms	10 to 15
Shock resistance	rectangular pulse sine pulse	AC and DC operation AC and DC operation	g/ms g/ms	5.1/5 and 3.5/10 7.9/5 and 5.2/10
Operating frequency z in operating cycles per hour	Rated operation	No-load op. frequency	1/h for AC-1 for AC-2 for AC-3	10000 1000 500 1000

Short-circuit protection

Fuse links	NH DIAZED NEOZED	Type 3NA Type 5SB Type 5SE		
Utilisation category gL/gG				
acc. to IEC 60 947-4-1 (DIN VDE 0660 Part 102)	Type of coordination "1" Type of coordination "2"		A A	25 10
Miniature circuit-breaker	C-characteristic		A	10

Load ratings with AC

AC-1 utilisation category, switching resistive load				
Rated operational current I_e at 55 °C to 400 V ¹⁾				
with screw connection		A		20
with tab connector		A		16
Ratings U_e of three-phase loads p.f. = 1		V		400
with screw connection		kW		13
with tab connector		kW		10
Minimum conductor cross-section with $I_{e\ load}$		mm ²		2.5

1) If the three main conducting paths are loaded with 20 A and $I > 10$ A for the fourth conducting

path; the permissible ambient temperature is 40 °C.

Technical data										
Load ratings with AC										
AC-2 and AC-3 utilisation categories										
Rated operational currents I_e up to 400 V	A	8.4								
Ratings of motors with slipping or squirrel-cage rotor at 50 Hz and 60 Hz and at 400 V	kW	4								
AC-5a utilisation category (permissible supply impedance: $\geq 0.5 \Omega$)										
Switching gas discharge lamps per main conducting path at 50 Hz 230 V										
		Uncorrected			Lead-lag					
Rating per lamp	W	18	36	58	18	36	58			
Rated operational current per lamp	A	0.37	0.43	0.67	2 x 0.11	2 x 0.21	2 x 0.32			
Number of lamps	unit	43	37	24	2 x 81	2 x 42	2 x 28			
Switching gas discharge lamps with correction, electronic ballast per main conducting path at 50 Hz 230 V										
		Parallel correction			Electr. ballast, 1 lamp		Electr. ballast, 2 lamps			
Rating per lamp	W	18	36	58	18	36	58	18	36	58
Capacitor	μF	4.5	4.5	7	6.8	6.8	10	10	10	22
Rated operational current per lamp	A	0.11	0.21	0.32	0.10	0.18	0.27	0.18	0.35	0.52
Number of lamps	unit	15	15	10	39	39	26	2 x 26	2 x 26	2 x 1
AC-5b utilisation category, switching incandescent lamps per main conducting path at 50 Hz 230 V										
	kW	1.6								
Load ratings with DC										
DC-1 utilisation category, switching resistive load ($\frac{L}{R} \leq 1 \text{ ms}$)										
Rated operational current I_e										
		Conducting paths connected in series		1	2	3	4			
		up to 24 V	A	16	16	18	20			
		60 V	A	6	16	18	20			
		110 V	A	2	6	16	20			
		220 V/240 V	A	0.8	1.6	6	20			
DC-3 and DC-5 utilisation categories, shunt and series motors ($\frac{L}{R} \leq 15 \text{ ms}$)										
Rated operational current I_e										
		Conducting paths connected in series		1	2	3	4			
		up to 24 V	A	10	16	16	18			
		60 V	A	0.5	5	16	16			
		110 V	A	0.15	0.35	10	10			
		220 V/240 V	A	–	–	1.75	2			
Conductor cross-sections for designs										
with screw connections										
Screw connection		M3								
Finely stranded with end sleeve (DIN 46 228, style A/D/C)	mm ²	2 x (0.75 to 2.5)								
Solid	mm ²	2 x (1 to 2.5)								
	mm ²	1 x 4								
with tab connectors										
Finely stranded		6.3 to 1	mm ²	0.5 to 1						
When using push-on contact acc. to DIN 46 245/46 247		6.3 to 2.5	mm ²	1 to 2.5						
Ⓢ and Ⓣ ratings (screw connection)										
Rated insulation voltage										
	AC	V	600							
Conventional thermal current										
	Free air and enclosed	A	20							
Maximum horsepower ratings (Ⓢ and Ⓣ-approved values)										
Ratings of three-phase motors at 60 Hz										
				1-phase			3-phase			
	at 115 V	hp	1/2	–			–			
	200 V	hp	1	–			3			
	230 V	hp	1 1/2	–			3			
	460 V/575 V	hp	–	–			5			
	600 V	hp	–	–			5			

3TG10 power relays

Accessories

For contactor	Design		Order No.	List Price \$	Weight approx.	Pack
Type	A	Max. rated operational currents I_n /AC-1 (at 55 °C) of contactors mm ²	PG 101		kg	Units

Links for paralleling (star jumpers)

• 3-pole without terminal ¹⁾²⁾						
3TG10	16 Star jumpers can be reduced by one pole	–	3RT1 916-4BA31		0.004	1
• 3-pole with terminal ¹⁾³⁾						
3TG10	40	25	3RT1 916-4BB31		0.013	1
• 4-pole with terminal ¹⁾⁴⁾						
3TG10	50	25	3RT1 916-4BB41		0.02	1

Circuit diagrams

Position of terminals

3TG10 10
1 NO

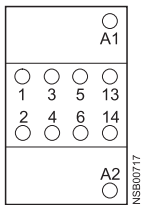

3TG10 01
1 NC

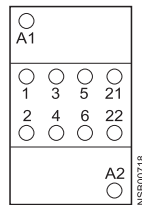

Internal circuit diagram

3TG10 10
1 NO
Ident. 10E

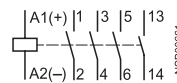

3TG10 01
1 NC
01E

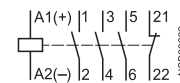

Dimension drawings

AC and DC operation

3TG10 ..-0..
with screw connections

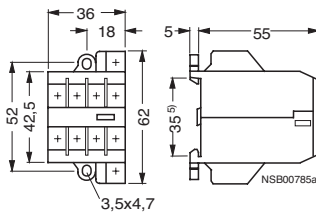

3TG10 ..-1..
with tab connectors

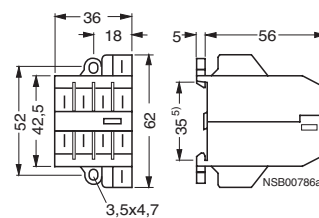

Accessories for 3TG10

3RT19 16-4BB41 links for paralleling, 4-pole, with terminal

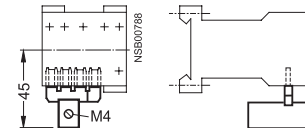

The links for paralleling can be reduced by one pole.

- 1) The links for paralleling can be reduced by one pole. The rated operational currents are valid for each pole. The links for paralleling are insulated.
- 2) Replacement type for 3TX44 90-2C.
- 3) Replacement type for 3TX44 90-2A.
- 4) Replacement type for 3TX44 90-2B.
- 5) Can be snapped onto 35 mm standard mounting rails.

Selection and ordering data

Siemens offers a wide range of plug-in relays to meet your industrial needs. Basic style relays are the most economical and are equipped with a mechanical flag indicator only. Premium style relays are full featured with LED and mechanical flag indication, push to test button and typically a latching hold down door which provides a method of activating the contacts without applying power to the coil. This feature is very handy during commissioning and troubleshooting. Premium Bifurcated style relays are ideal for low minimum holding current requirements on the contacts. Typical minimum holding current for bifurcated contacts is 3mA instead of 100mA.

Relays are divided up by the following functions for selection:

- Base style
- Contact Arrangement
- Contact Rating
- Coil Voltage
- Optional Features (Basic, Premium and Premium Bifurcated)



Square Base (Narrow)

Contacts	Contact Rating (A)	Coil Voltage	Basic Relay	Premium Relay	Uses Socket 3TX7144-	Uses Clip 3TX7144-	Socket Access Set	Panel Mount Adaptor 3TX7144-	DIN Rail Mount Adaptor 3TX7144-
SPDT	15	12VDC	3TX7110-5BB03C	3TX7110-5JB03	4E7	1L7	B	3L5	3L4
		24 VDC	3TX7110-5BC03C	3TX7110-5JC03	4E7	1L7	B	3L5	3L4
		24 VAC	3TX7110-5BC13C	3TX7110-5JC13	4E7	1L7	B	3L5	3L4
		120 VAC	3TX7110-5BF13C	3TX7110-5JF13	4E7	1L7	B	3L5	3L4
		240 VAC	—	3TX7110-5JG13	4E7	1L7	B	3L5	3L4



Square Base (Standard)

Contacts	Contact Rating (A)	Coil Voltage	Basic Relay	Premium Relay	Uses Socket 3TX7144-	Uses Clip 3TX7144-	Socket Access Set	Panel Mount Adaptor 3TX7144-	DIN Rail Mount Adaptor 3TX7144-
DPDT	12	24 VDC	3TX7111-3DC03C	3TX7111-3LC03	4E5	1L6	B	3L7	3L6
		24 VAC	3TX7111-3DC13C	3TX7111-3LC13	4E5	1L6	B	3L7	3L6
		120 VAC	3TX7111-3DF13C	3TX7111-3LF13	4E5	1L6	B	3L7	3L6
DPDT	15	12 VDC	3TX7114-5DB03C	3TX7114-5LB03	4E6	1L6	B	3L7	3L6
		24VDC	3TX7114-5DC03C	3TX7114-5LC03	4E6	1L6	B	3L7	3L6
		24VAC	3TX7114-5DC13C	3TX7114-5LC13	4E6	1L6	B	3L7	3L6
		120 VAC	3TX7114-5DF13C	3TX7114-5LF13	4E6	1L6	B	3L7	3L6
DPDT	10	240 VAC	3TX7114-5DH13C	3TX7114-5LH13	4E6	1L6	B	3L7	3L6
		12 VDC	3TX7115-5DB03C	—	4E4	1L12	A	—	—
		24VDC	3TX7115-5DC03C	3TX7115-5LC03	4E4	1L12	A	—	—
		24VAC	3TX7115-5DC13C	3TX7115-5LC13	4E4	1L12	A	—	—
DPDT Note: No Lock Down Door on Premium Style	20	120 VAC	3TX7115-5DF13C	3TX7115-5LF13	4E4	1L12	A	—	—
		12 VDC	—	3TX7119-5LB03	4E4	1L12	A	—	—
		24VDC	—	3TX7119-5LC03	4E4	1L12	A	—	—
		240 VAC	—	3TX7119-5LH13	4E4	1L12	A	—	—

Option	Basic	Premium
Mechanical Flag	✓	✓
Push To Test		✓
Lock Down Door		✓
LED		✓

Note: See page 11/90 for socket accessories.

Function Relays, Interfaces and Converters

SIRIUS
RELAYS

3TX71 plug-in relays

• Revised •
12/10/14

Selection and ordering data



Square Base (Standard)

Contacts	Contact Rating (A)	Coil Voltage	Basic Relay	Premium Relay	Premium Bifurcated	Uses Socket 3TX7144-	Uses Clip 3TX7144-	Socket Access Set	Panel Mount Adaptor 3TX7144-	DIN Rail Mount Adaptor 3TX7144-
3PDT	15	24VDC	3TX7116-5FC03C	3TX7116-5NC03	—	4E8	1L9	A	1M3	1M4
		24VAC	3TX7116-5FC13C	3TX7116-5NC13	—	4E8	1L9	A	1M3	1M4
		120 VAC	3TX7116-5FF13C	3TX7116-5NF13	—	4E8	1L9	A	1M3	1M4
3PDT	10	24VDC	—	3TX7115-5NC03	—	4E4	1L12	A	—	—
		120 VAC	3TX7115-5FF13C	3TX7115-5NF13	—	4E4	1L12	A	—	—
4PDT	6A for Basic and Premium and 3A for Bifurcated	24VDC	3TX7111-3HC03C	3TX7111-3PC03	3TX7111-5PC03B	4E5	1L6	B	3L7	3L6
		24VAC	3TX7111-3HC13C	3TX7111-3PC13	—	4E5	1L6	B	3L7	3L6
		120 VAC	3TX7111-3HF13C	3TX7111-3PF13	3TX7111-5PF13B	4E5	1L6	B	3L7	3L6
		240 VAC	—	3TX7111-3PG13	—	4E5	1L6	B	3L7	3L6
4PDT	15	24VDC	3TX7117-5HC03C	3TX7117-5PC03	—	4E9	1L10	A	1M5	1M6
		24VAC	3TX7117-5HC13C	3TX7117-5PC13	—	4E9	1L10	A	1M5	1M6
		120 VAC	3TX7117-5HF13C	3TX7117-5PF13	—	4E9	1L10	A	1M5	1M6



Specialty Relay

Contacts	Contact Rating (A)	Coil Voltage	Basic Relay	Premium Relay	Premium Bifurcated	Uses Socket 3TX7144-	Uses Clip 3TX7144-	Socket Access Set	Panel Mount Adaptor 3TX7144-	DIN Rail Mount Adaptor 3TX7144-
DPDT Latching	16	24 VDC	3TX7137-5DC03	—	—	1E4	1L12	—	—	—
		120 VAC	3TX7137-5DF13	—	—	1E4	1L12	—	—	—

Option	Basic	Premium	Premium Bifurcated
Mechanical Flag	✓	✓	✓
Push To Test		✓	✓
Lock Down Door		✓	✓
LED		✓	✓

Note: See page 11/90 for socket accessories.

Selection and ordering data



Standard Octal Base

Contacts	Contact Rating (A)	Coil Voltage	Basic Relay	Premium Relay	Uses Socket 3TX7144-	Uses Clip 3TX7144-	Socket Access Set
DPDT	10	12 VDC	3TX7112-1DB03C	3TX7112-1LB03	4E2	1L14	A
		24VDC	3TX7112-1DC03C	3TX7112-1LC03	4E2	1L14	A
		24VAC	3TX7112-1DC13C	3TX7112-1LC13	4E2	1L14	A
		120 VAC	3TX7112-1DF13C	3TX7112-1LF13	4E2	1L14	A
		240 VAC	3TX7112-1DG13C	3TX7112-1LG13	4E2	1L14	A
3PDT	10	12 VDC	3TX7112-1FB03C	—	4E3	1L14	A
		24VDC	3TX7112-1FC03C	3TX7112-1NC03	4E3	1L14	A
		24VAC	3TX7112-1FC13C	3TX7112-1NC13	4E3	1L14	A
		120 VAC	3TX7112-1FF13C	3TX7112-1NF13	4E3	1L14	A
		240 VAC	—	3TX7112-1NG13	4E3	1L14	A



Hermetically Sealed

Contacts	Contact Rating (A)	Coil Voltage	Basic Relay	Uses Socket 3TX7144-	Uses Clip 3TX7144-	Socket Access Set
DPDT	12	12 VDC	3TX7127-5HB00	3TX7144-4E2	1L12	A
		24 VDC	3TX7127-5HC00	3TX7144-4E2	1L12	A
		120 VAC	3TX7127-5HF10	3TX7144-4E2	1L12	A
4PDT	3	24VDC	3TX7127-3HC00	3TX7144-4E5	1L11	B
		24VAC	3TX7127-3HC10	3TX7144-4E5	1L11	B
		120 VAC	3TX7127-3HF10	3TX7144-4E5	1L11	B
4PDT	5	12 VDC	3TX7127-3HB03	3TX7144-4E5	1L11	B
		24VDC	3TX7127-3HC03	3TX7144-4E5	1L11	B
		120 VAC	3TX7127-3HF13	3TX7144-4E5	1L11	B

Note: See page 11/90 for socket accessories.

• Revised •
09/30/14

3TX71 plug-in relays

Selection and ordering data

Open Power Relays

Contacts	Contact Rating (A)	Coil Voltage	Basic Relay	Metal Cover 7144-
SPST NO-DM	40	24VAC	3TX7130-0AC13	1M0
SPST NO-DM		120 VAC	3TX7130-0AF13	1M0
SPST NO-DM		240 VAC	3TX7130-0AH13	1M0
SPST NC-DM	40	120 VAC	3TX7130-0QF13	1M0
SPDT		24 VAC	3TX7130-0BC13	1M0
SPDT		120 VAC	3TX7130-0BF13	1M0
SPDT		240 VAC	3TX7130-0BH13	1M0
SPDT		277 VAC	3TX7130-0BS13	1M0
DPDT	40	24 VAC	3TX7130-0DC13	1M0
		120 VAC	3TX7130-0DF13	1M0
		240 VAC	3TX7130-0DH13	1M0
		277 VAC	3TX7130-0DS13	1M0
		12 VDC	3TX7130-0DB03	1M0
		24 VDC	3TX7130-0DC03	1M0
		48 VDC	3TX7130-0DD03	1M0
DPST NO	40	110 VDC	3TX7130-0DF03	1M0
		24 VAC	3TX7130-0CC13	1M0
		120 VAC	3TX7130-0CF13	1M0
		240 VAC	3TX7130-0CH13	1M0
		12 VDC	3TX7130-0CB03	1M0
		24 VDC	3TX7130-0CC03	1M0
DPDT (Mag Blowout)	40	48 VDC	3TX7130-0CD03	1M0
		120 VAC	3TX7130-0RF13	1M0
		12 VDC	3TX7130-0RB03	1M0
		24 VDC	3TX7130-0RC03	1M0
		48 VDC	3TX7130-0RD03	1M0
		110 VDC	3TX7130-0RF03	1M0



Enclosed Power Relays

Contacts	Contact Rating (A)	Coil Voltage	Basic Relay
DPST-NO	30	24VAC	3TX7131-4CC13
		120 VAC	3TX7131-4CF13
		230 VAC	3TX7131-4CH13
DPDT	30 NO/ 3 NC	12 VDC	3TX7131-4DB03
		24 VDC	3TX7131-4DC03
		24VAC	3TX7131-4DC13
		120 VAC	3TX7131-4DF13
		230 VAC	3TX7131-4DH13



Note: See page 11/90 for socket accessories.

Selection and ordering data



Octal Based Timers

Contacts	Contact Rating (A)	Coil Voltage	Basic Relay	Time Range	Function	Uses Socket 3TX7144-	Uses Clip 3TX7144-	Socket Access Set	Panel Mount Adaptor 3TX7144-	DIN Rail Mount Adaptor 3TX7144-
DPDT	12	24 V AC/DC	OND-DFOB-24	0.1S - 10h	A, C	3TX7144-4E2	1L8	A	—	—
		120 V AC/DC	OND-DFOB-120	0.1S - 10h	A, C	3TX7144-4E2	1L8	A	—	—
		240 VAC	OND-DFOB-240	0.1S - 10h	A, C	3TX7144-4E2	1L8	A	—	—
DPDT	12	24V AC/DC	OFD-DFOB-24	0.1S - 10h	D, E	3TX7144-4E3	1L8	A	—	—
		120 V AC/DC	OFD-DFOB-120	0.1S - 10h	D, E	3TX7144-4E3	1L8	A	—	—
		240 VAC	OFD-DFOB-240	0.1S - 10h	D, E	3TX7144-4E3	1L8	A	—	—



Square Based Timers

Contacts	Contact Rating (A)	Coil Voltage	Basic Relay	Time Range	Function	Uses Socket 3TX7144-	Uses Clip 3TX7144-	Socket Access Set	Panel Mount Adaptor 3TX7144-	DIN Rail Mount Adaptor 3TX7144-
DPDT	12	24V AC/DC	OND-DFSB-24	0.1S - 10h	A, C	3TX7144-1E4	1L8	—	—	—
		120 V AC/DC	OND-DFSB-120	0.1S - 10h	A, C	3TX7144-1E4	1L8	—	—	—
		240 VAC	OND-DFSB-240	0.1S - 10h	A, C	3TX7144-1E4	1L8	—	—	—
DPDT	12	24V AC/DC	OFD-DFSB-24	0.1S - 10h	D, E	3TX7144-1E4	1L8	—	—	—
		120 V AC/DC	OFD-DFSB-120	0.1S - 10h	D, E	3TX7144-1E4	1L8	—	—	—
		240 VAC	OFD-DFSB-240	0.1S - 10h	D, E	3TX7144-1E4	1L8	—	—	—

Selecting Function	
Function for OND	SW I
On Delay	OFF
Interval	ON
Function for OFD	
Function for OFD	SW I
Off Delay	OFF
One Shot	ON

Selecting Time Range			
Time Range	SW II	SW III	SW IV
0.1s - 1 s	OFF	OFF	OFF
1s - 10s	OFF	OFF	ON
10s - 100s	OFF	ON	OFF
0.1m - 1m	OFF	ON	ON
1m - 10m	ON	OFF	OFF
10m - 100m	ON	OFF	ON
0.1h - 1h	ON	ON	OFF
1h - 10h	ON	ON	ON



Front Panel Timers

Contacts	Contact Rating (A)	Coil Voltage	Basic Relay	Time Range	Function	Uses Socket 3TX7144-	Uses Clip 3TX7144-	Socket Access Set	Panel Mount Adaptor 3TX7144-	DIN Rail Mount Adaptor 3TX7144-
DPDT	12	12-240V AC/DC	OFD-DFPR-00	0.1S - 9990h	A,B,C,D,E,F,G,H,I,J	3TX7144-4E3	1L25	—	—	—
SPDT		12-240V AC/DC	OND-DFPR-01	0.1S - 9990h	A,B,C,D,E,F,G,H,I,J	3TX7144-4E2	1L25	—	—	—
DPDT		12-240V AC/DC	OND-DFPR-02	0.1S - 9990h	A,B,C	3TX7144-4E2	1L25	—	—	—

Note: See page 11/90 for socket accessories.

Multifunction Timer Modes		
Function	Name	Description
A	On Delay (Power On)	When input voltage U is applied, timing delay t begins. Relay contacts R change state after the time delay is complete. Contacts R return to their shelf state when input voltage U is removed. Trigger switch is not used in this function.
B	Repeat Cycle (Starting Off)	When input voltage U is applied, time delay t begins. When time delay t is complete, relay contacts R change state for time delay t. This cycle will repeat until input voltage U is removed. Trigger switch is not used in this function.
C	Interval (Power On)	When input voltage U is applied, relay contacts R change state immediately and timing cycle begins. When time delay is complete, contacts return to shelf state. When input voltage U is removed, contacts will also return to their shelf state. Trigger switch is not used in this function.
D	Off Delay (S Break)	Input voltage U must be applied continuously. When trigger switch S is closed, relay contacts R change state. When trigger switch S is opened, delay t begins. When delay t is complete, contacts R return to their shelf state. If trigger switch S is closed before time delay t is complete, then time is reset. When trigger switch S is opened, the delay begins again, and relay contacts R remain in their energized state. If input voltage U is removed, relay contacts R return to their shelf state.
E	Retriggerable One Shot	Upon application of input voltage U, the relay is ready to accept trigger signal S. Upon application of the trigger signal S, the relay contacts R transfer and the preset time t begins. At the end of the preset time t, the relay contacts R return to their normal condition unless the trigger switch S is opened and closed prior to time out t (before preset time elapses). Continuous cycling of the trigger switch S at a rate faster than the preset time will cause the relay contacts R to remain closed. If input voltage U is removed, relay contacts R return to their shelf state.
F	Repeat Cycle (Starting On)	When input voltage U is applied, relay contacts R change state immediately and time delay t begins. When time delay t is complete, contacts return to their shelf state for time delay t. This cycle will repeat until input voltage U is removed. Trigger switch is not used in this function.
G	Pulse Generator	Upon application of input voltage U, a single output pulse of 0.5 seconds is delivered to relay after time delay t. Power must be removed and reapplied to repeat pulse. Trigger switch is not used in this function.
H	One Shot	Upon application of input voltage U, the relay is ready to accept trigger signal S. Upon application of the trigger signal S, the relay contacts R transfer and the preset time t begins. During time-out, the trigger signal S is ignored. The relay resets by applying the trigger switch S when the relay is not energized.
I	On/Off Delay (S Make/Break)	Input voltage U must be applied continuously. When trigger switch S is closed, time delay t begins. When time delay t is complete, relay contacts R change state and remain transferred until trigger switch S is opened. If input voltage U is removed, relay contacts R return to their shelf state.
J	Memory Latch (S Make)	Input voltage U must be applied continuously. Output changes state with every trigger switch S closure. If input voltage U is removed, relay contacts R return to their shelf state.

Socket Accessories

Access. Series	MOV	MOV	R/C	R/C	Diode
	24VAC/DC	120VAC/DC	6-24VAC/DC	110-240VAC/DC	6-250VDC
A	3TX7144-H1	3TX7144-H20	3TX7144-H4	3TX7144-H5	3TX7144-H6
B	3TX7144-H9	3TX7144-H17	—	—	3TX7144-H12

Function Relays, Interfaces and Converters

SIRIUS
RELAYS

• Revised •
09/30/14

3TX71 plug-in relays

1
2
3
4
5
6
7
8
9
10
11

General specifications

Contact Characteristics		Units	3TX7109	3TX7110	3TX7111					
Number and Type of Contacts			SPDT	SPDT	SPDT	DPDT	DPDT	4PDT	4PDT	
Contact Material			Silver Alloy	Silver Alloy	Silver Alloy	Silver Alloy	Silver Alloy	Silver Alloy	Silver Alloy	
Thermal (Carrying) Current	A		20	15	3 (Bifurcated)	12	3 (Bifurcated)	6	3 (Bifurcated)	
Maximum Switching Voltage	V		300	300	300	300	300	300	300	
Switching Current at Voltage			Resistive	16A @240V	15A @240V	3A @240V	—	3A @240V	6A @240V	3A @240V
			Resistive	16A @120V	15A @120V	—	12A @120V	3A @120V	6A @120V	3A @120V
			Resistive	16A @ 28	15A @ 28	—	12A @ 28	3A @ 30	6A @ 28	3A @ 30
			HP	1/2 @ 120VAC	1/2 @ 120VAC	—	1/3 @ 120VAC	1/16 @ 120VAC	1/3 @ 120VAC	1/16 @ 120VAC
			HP	1 @ 240VAC	1 @ 240VAC	—	—	—	1 @ 240VAC	—
Pilot Duty			B300	B300	—	B300	—	B300	—	
Minimum Switching Requirement	mA		100 @ 5VDC (.5W)	100 @ 5VDC (.5W)	3 @ 17VDC (.4W)	100 @ 5VDC (.5W)	3 @ 17VDC (.4W)	100 @ 5VDC (.5W)	3 @ 17VDC (.4W)	
Coil Characteristics										
Voltage Range	AC	V	6...240	6...240	6...240	6...240	6...240	6...240	6...240	
	DC	V	6...125	6...125	6...125	6...125	6...125	6...125	6...125	
Operating Range	AC	%	85 to 110	85 to 110	85 to 110	85 to 110	85 to 110	85 to 110	85 to 110	
	DC	%	80 to 110	80 to 110	80 to 110	80 to 110	80 to 110	80 to 110	80 to 110	
Average Consumption	AC	VA	1.2	0.9	0.9	1.2	1.2	1.2	1.2	
	DC	W	0.9	0.7	0.7	0.9	0.9	0.9	0.9	
Drop-out Voltage Threshold	AC	%	15	15	15	15	15	15	15	
	DC	%	10	10	10	10	10	10	10	
Performance Characteristics										
Electrical Life (UL508)	Operations @ Rated Current	(Resistive)	100,000	100,000	100,000	200,000	200,000	200,000	200,000	
Mechanical Life	Unpowered		10,000,000	10,000,000	10,000,000	10,000,000	10,000,000	10,000,000	10,000,000	
Operating Time (response time)		ms	20	20	20	20	20	20	20	
Dielectric Strength	Between Coil and Contact	V(rms)	2500	2500	2500	2500	2500	2500	2500	
	Between Poles	V(rms)	1500	1500	1500	1500	1500	1500	1500	
	Between Contacts	V(rms)	1500	1500	1500	1500	1500	1500	1500	
Environment										
Product Certifications	Standard Version		UL,RoHS	UL,RoHS	UL,RoHS	UL,RoHS	UL,RoHS	UL,RoHS	UL,RoHS	
Ambient Air Temperature around the Device	Storage	°C	-40...+85	-40...+85	-40...+85	-40...+85	-40...+85	-40...+85	-40...+85	
	Operational	°C	-40...+55	-40...+55	-40...+55	-40...+55	-40...+55	-40...+55	-40...+55	
Vibration Resistance	Operational	g-n	3, 10 - 55 Hz	3, 10 - 55 Hz	3, 10 - 55 Hz	3, 10 - 55 Hz	3, 10 - 55 Hz	3, 10 - 55 Hz	3, 10 - 55 Hz	
Shock Resistance		g-n	10	10	10	10	10	10	10	
Degree of Protection			IP40	IP40	IP40	IP40	IP40	IP40	IP40	
Weight		grams	36	29	29	36	36	36	36	

Contact Characteristics		Units	3TX7112	3TX7114	3TX7115	3TX7116	3TX7117			
Number and Type of Contacts			DPDT	3PDT	DPDT	DPDT	3PDT	3PDT	4PDT	
Contact Material			Silver Alloy	Silver Alloy	Silver Alloy	Silver Alloy	Silver Alloy	Silver Alloy	Silver Alloy	
Thermal (Carrying) Current	A		10	15	15	10	15	15	15	
Maximum Switching Voltage	V		300	300	300	300	300	300	300	
Switching Current at Voltage			Resistive	10A @240V	10A @240V	12A @277V	10A @277V	10A @277V	12A @277V	12A @277V
			Resistive	10A @120V	10A @120V	15A @120V	10A @120V	10A @120V	15A @120V	15A @120V
			Resistive	10A @ 28	10A @ 28	12A @ 28	10A @ 28	10A @ 28	12A @ 28	12A @ 28
			HP	1/3 @ 120VAC	1/3 @ 120VAC	1/2 @ 120VAC	1/3 @ 120VAC	1/3 @ 120VAC	1/2 @ 120VAC	1/2 @ 120VAC
			HP	1/2 @ 240VAC	1/2 @ 240VAC	1 @ 240VAC	1/2 @ 240VAC	1/2 @ 240VAC	3/4 @ 240VAC	3/4 @ 240VAC
Pilot Duty			B300	B300	B300	B300	B300	B300	B300	
Minimum Switching Requirement	mA		100 @ 5VDC (.5W)	100 @ 5VDC (.5W)	100 @ 5VDC (.5W)	100 @ 5VDC (.5W)	100 @ 5VDC (.5W)	100 @ 5VDC (.5W)	100 @ 5VDC (.5W)	
Coil Characteristics										
Voltage Range	AC	V	6...240	6...240	6...240	6...240	6...240	6...240	6...240	
	DC	V	6...125	6...125	6...125	6...125	6...125	6...125	6...125	
Operating Range	AC	%	85 to 110	85 to 110	85 to 110	85 to 110	85 to 110	85 to 110	85 to 110	
	DC	%	80 to 110	80 to 110	80 to 110	80 to 110	80 to 110	80 to 110	80 to 110	
Average Consumption	AC	VA	1.2	1.2	1.2	1.2	1.2	1.5	1.5	
	DC	W	0.9	0.9	0.9	0.9	0.9	1.4	1.5	
Drop-out Voltage Threshold	AC	%	15	15	15	15	15	15	15	
	DC	%	10	10	10	10	10	10	10	
Performance Characteristics										
Electrical Life (UL508)	Operations @ Rated Current	(Resistive)	200,000	200,000	100,000	100,000	100,000	200,000	200,000	
Mechanical Life	Unpowered		10,000,000	10,000,000	10,000,000	10,000,000	10,000,000	10,000,000	10,000,000	
Operating Time (response time)		ms	20	20	20	20	20	20	20	
Dielectric Strength	Between Coil and Contact	V(rms)	2500	2500	2500	2500	2500	2500	2500	
	Between Poles	V(rms)	1500	1500	1500	1500	1500	2500	2500	
	Between Contacts	V(rms)	1500	1500	1500	1500	1500	1500	2500	
Environment										
Product Certifications	Standard Version		UL,RoHS	UL,RoHS	UL,RoHS	UL,RoHS	UL,RoHS	UL,RoHS	UL,RoHS	
Ambient Air Temperature around the Device	Storage	°C	-40...+85	-40...+85	-40...+85	-40...+85	-40...+85	-40...+85	-40...+85	
	Operational	°C	-40...+55	-40...+55	-40...+55	-40...+55	-40...+55	-40...+55	-40...+55	
Vibration Resistance	Operational	g-n	3, 10 - 55 Hz	3, 10 - 55 Hz	3, 10 - 55 Hz	3, 10 - 55 Hz	3, 10 - 55 Hz	3, 10 - 55 Hz	3, 10 - 55 Hz	
Shock Resistance		g-n	10	10	10	10	10	10	10	
Degree of Protection			IP40	IP40	IP40	IP40	IP40	IP40	IP40	
Weight		grams	89	89	36	88	88	60	60	

3TX71 plug-in relays

General specifications

Contact Characteristics		Units	3TX7119	3TX7127			3TX7130
Number and Type of Contacts			DPDT	DPDT	4PDT	4PDT	All
Contact Material			Silver Alloy	Silver Alloy	Fine Silver	Silver Alloy	Silver Alloy
Thermal (Carrying) Current	A		20	12	3	5	40
Maximum Switching Voltage	V		600	300	300	300	600
Switching Current at Voltage	Resistive		20A @300V	12A @240V	3A @240V	12A @240V	40A @277V
	Resistive		—	12A @120V	3A @120V	—	—
	Resistive		20A @ 28	12A @ 28	3A @ 30	—	40A @ 28
	HP		1/3 @ 120VAC	1/3 @ 120VAC	1/16 @ 120VAC	—	—
	HP		1/2 @ 600VAC	1/2 @ 240VAC	1/10 @ 240VAC	—	—
	Pilot Duty		B600	B300	—	—	—
Minimum Switching Requirement	mA		100 @ 5VDC (.5W)	100 @ 5VDC (.5W)	10 @ 5VDC (.5W)	100 @ 5VDC (.5W)	1000 @ 12VAC/DC
Coil Characteristics							
Voltage Range	AC	V	6...240	6...240	6...240	6...240	6...600
	DC	V	6...125	6...125	6...125	6...125	6...600
Operating Range	AC	%	85 to 110	85 to 110	85 to 110	85 to 110	85 to 110
	DC	%	80 to 110	80 to 110	80 to 110	80 to 110	80 to 110
Average Consumption	AC	VA	2.75	1.2	1.2	1.2	10
	DC	W	2	0.9	0.9	0.9	4
Drop-out Voltage Threshold	AC	%	15	15	15	15	10
	DC	%	10	10	10	10	10
Performance Characteristics							
Electrical Life (UL508)	Operations @ Rated Current	(Resistive)	100,000	100,000	100,000	100,000	100,000
Mechanical Life	Unpowered		10,000,000	10,000,000	10,000,000	10,000,000	1,000,000
Operating Time (response time)		ms	20	20	20	20	30
Dielectric Strength	Between Coil and Contact	V(rms)	2000	1,500	1240	1240	2200
	Between Poles	V(rms)	2000	1,500	1240	1240	2200
	Between Contacts	V(rms)	1500	1500	500	500	1500
Environment							
Product Certifications	Standard Version		UL	UL,RoHS	UL,RoHS	UL,RoHS	UL
Ambient Air Temperature around the Device	Storage	°C	-40...+85	-40...+85	-40...+85	-40...+85	-40...+85
	Operational	°C	-40...+55	-40...+55	-40...+70	-40...+70	-40...+70
Vibration Resistance	Operational	g-n	3, 10 - 55 Hz	3, 10 - 55 Hz	3, 10 - 55 Hz	3, 10 - 55 Hz	3, 10 - 55 Hz
Shock Resistance		g-n	10	10	10	10	—
Degree of Protection			IP40	IP67	IP67	IP67	Open
Weight		grams	88	130	45	45	227 to 312

Contact Characteristics		Units	3TX7131		3TX7132		3TX7136	3TX7137
Number and Type of Contacts			DPST-NO	DPDT	DPDT	SPDT	SPDT	DPDT
Contact Material			Silver Alloy	Silver Alloy	Silver Alloy	Silver Alloy	Silver Alloy	Silver Alloy
Thermal (Carrying) Current	A		30	30 DPDT-NO	3 DPDT-NC	30 SPDT-NO	3 DPDT-NC	12
Maximum Switching Voltage	V		600	300	300	300	300	300
Switching Current at Voltage	Resistive		20A @300V	30A @277V	3A @277V	30A @277V	3A @277V	12A @240V
	Resistive		—	—	—	—	—	16A @120V
	Resistive		20A @ 28	20A @ 28	3A @ 28	10A @ 28	3A @ 28	12A @ 28
	HP		1/3 @ 120VAC	1 @ 120VAC	—	1 @ 120VAC	—	1/2 @ 120VAC
	HP		1/2 @ 600VAC	3 @ 240VAC	—	2 @ 240VAC	—	1/3 @ 240VAC
	Pilot Duty		—	—	—	—	—	B300
Minimum Switching Requirement	mA		500 @ 12VAC/DC	500 @ 12VAC/DC	500 @ 12VAC/DC	1000 @ 12VAC/5VDC	500 @ 12VAC/DC	100 @ 5VDC (.5W)
Coil Characteristics								
Voltage Range	AC	V	12...240	12...240	12...240	12...277	12...277	12...120
	DC	V	6...110	6...110	6...110	5...110	5...110	12...110
Operating Range	AC	%	85 to 120	85 to 120	85 to 120	85 to 120	85 to 120	85 to 110
	DC	%	75 to 120	75 to 120	75 to 120	75 to 120	75 to 120	80 to 110
Average Consumption	AC	VA	4	4	4	2.8	2.8	1.8
	DC	W	1.7	1.7	1.7	1	1	1.8
Drop-out Voltage Threshold	AC	%	10	10	10	10	10	15
	DC	%	10	10	10	10	10	10
Performance Characteristics								
Electrical Life (UL508)	Operations @ Rated Current	(Resistive)	100,000	100,000	100,000	100,000	100,000	100,000
Mechanical Life	Unpowered		5,000,000	5,000,000	5,000,000	10,000,000	10,000,000	10,000,000
Operating Time (response time)		ms	15	15	15	15	15	35
Dielectric Strength	Between Coil and Contact	V(rms)	4000	4000	4000	2500	2500	1500
	Between Poles	V(rms)	2000	2000	2000	1500	1500	500
	Between Contacts	V(rms)	1500	1500	1500	1500	1500	1500
Environment								
Product Certifications	Standard Version		UL	UL	UL	UL	UL	UL
Ambient Air Temperature around the Device	Storage	°C	-40...+85	-40...+85	-40...+85	-40...+85	-40...+85	-40...+85
	Operational	°C	-40...+55	-40...+55	-40...+55	-40...+55	-40...+55	-40...+70
Vibration Resistance	Operational	g-n	3, 10 - 55 Hz	3, 10 - 55 Hz	3, 10 - 55 Hz	3, 10 - 55 Hz	3, 10 - 55 Hz	3, 10 - 55 Hz
Shock Resistance		g-n	10	10	10	10	10	10
Degree of Protection			—	—	—	—	—	IP40
Weight		grams	86	86	86	33	33	110

1
2
3
4
5
6
7
8
9
10
11

Overview

Contact arrangement - throws

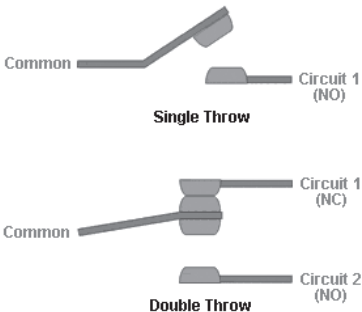

Throw is the number of different closed contact positions per pole. In other words a throw describes the total number of different circuits each pole controls.

The following abbreviations are used to indicate contact configurations:

- SPST** Single-pole, single-throw
- SPDT** Single-pole, double-throw
- DPST** Double-pole, single-throw
- DPDT** Double-pole, double-throw

Contact arrangement - break

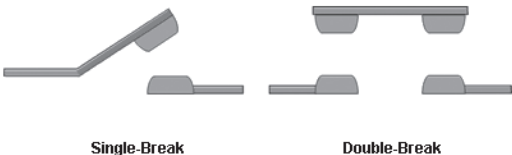

Break is the number of separate contacts the switch uses to open or close an individual circuits. If the relay breaks the circuit in one place, then it is a single break relay. If the relay breaks the circuit in two places, then it is a double break relay.

Contact arrangements overview

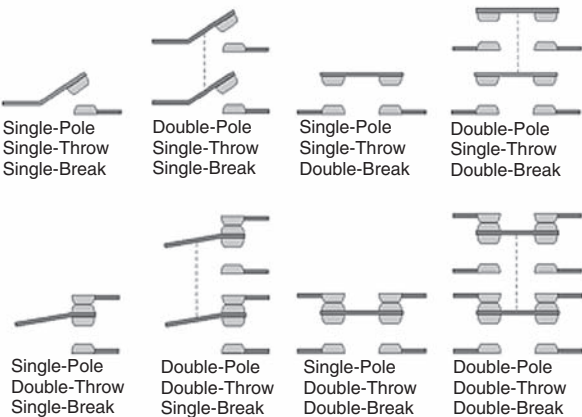

This illustration shows various contact arrangement types.

3TX71 plug-in relays

Circuit diagrams

3TX7109 (SPDT)

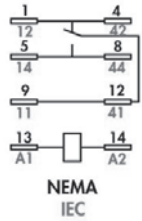

3TX7110
SPDT

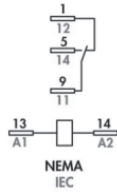

3TX7111
DPDT

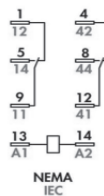

3TX7111
4PDT



3TX7112
DPDT

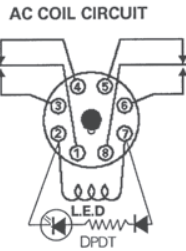

3TX7112
3PDT

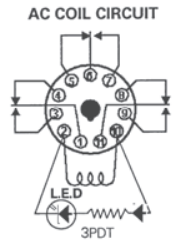

3TX7112-1L, -1D
DPDT

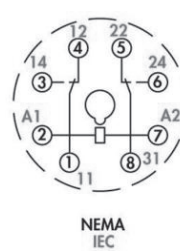

3TX7112-1N, -1F
3PDT

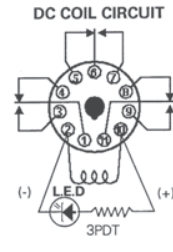
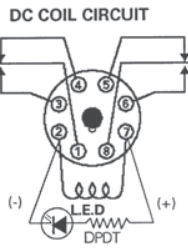
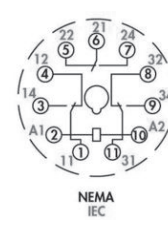

3TX7113
DPDT, 3PST, 3PDT

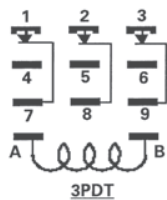
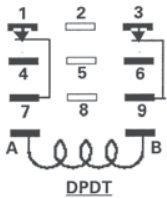
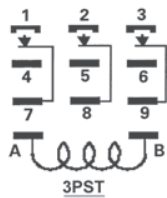

3TX7114
DPDT

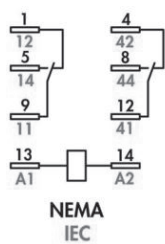

3TX7115
DPDT

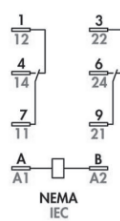

3TX7115
3PDT

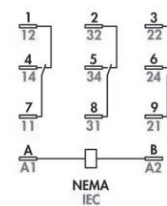

Circuit diagrams

3TX7116

3PDT

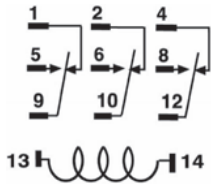

3TX7117

4PDT

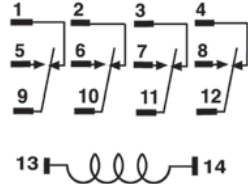

3TX7119 (DPDT)

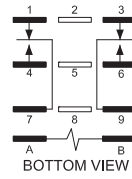

3TX7119 (3PDT)

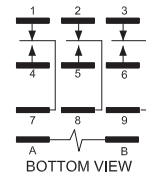

3TX7121

DPDT, 3PDT

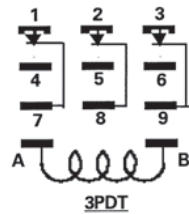
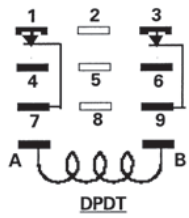

3TX7125

DPDT

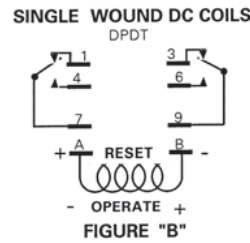
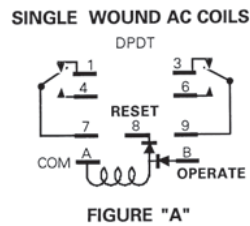

3TX7126/ 3TX7127

4PDT

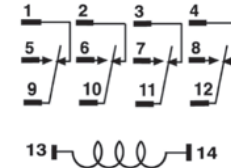

3TX7127 (DPDT)

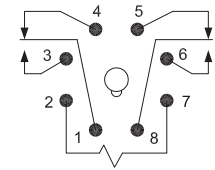

3TX7127 (3PDT)

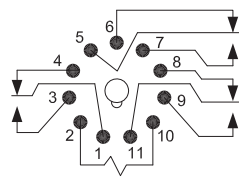

3TX7130

SPST-NO



3TX7130

SPDT

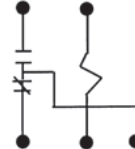

3TX7130

DPST-NO

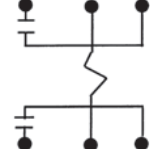

3TX7130

SPST-NC



3TX7130

DPDT

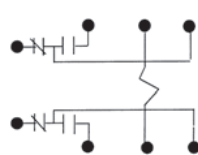

3TX7130 (DPDT)

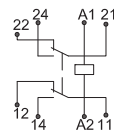

3TX7131 (DPST-NO) (AC)

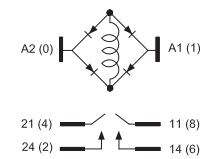

Function Relays, Interfaces and Converters

Coupling Relays and Interfaces

SIRIUS
RELAYS

3TX71 plug-in relays

Circuit diagrams

3TX7131 (DPST-NO) (DC)

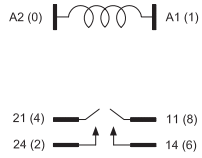

3TX7131 (DPDT) (AC)

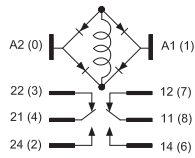

3TX7131 (DPDT) (DC)

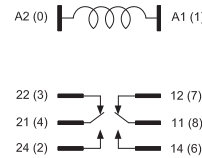

3TX7132 (SPDT) (AC)

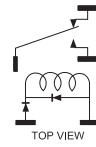

3TX7132 (SPDT) (DC)



**3TX7136
DPDT**

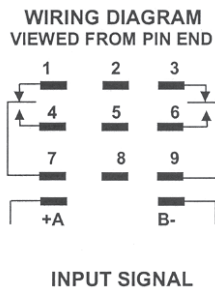

3TX7137 (DPDT) (AC)

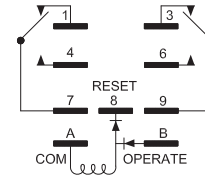

3TX7137 (DPDT) (DC)

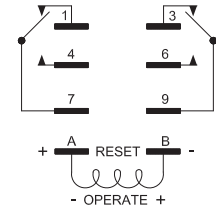

OFD-DFOB (DPDT)

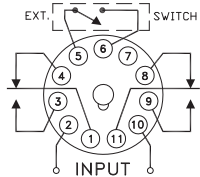

OND-DFOB (DPDT)

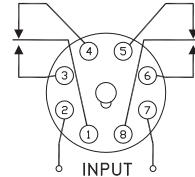

OFD-DFSB (DPDT)

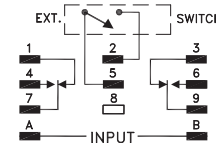

OND-DFSB (DPDT)

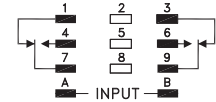

OFD-DFPR-00 (DPDT)

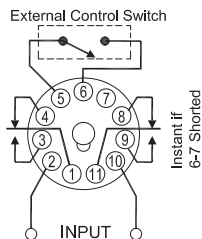

OND-DFPR-01 (SPDT)

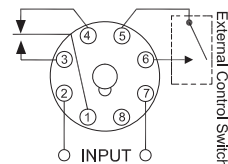

OND-DFPR-02 (DPDT)

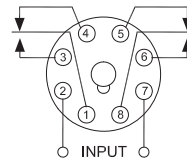

SIRIUS RELAYS

3TX71 plug-in relays

- 1
- 2
- 3
- 4
- 5
- 6
- 7
- 8
- 9
- 10
- 11

Dimension drawings

3TX7109 (SPDT) (clear cover)

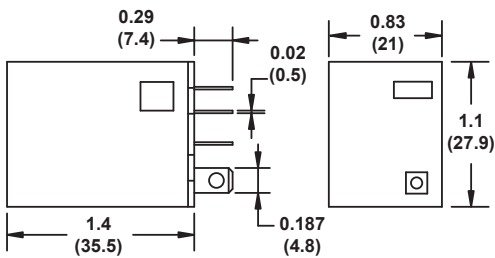

3TX7109 (SPDT) (full feature)

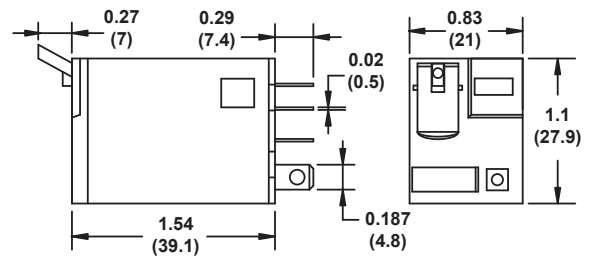

3TX7110 SPDT

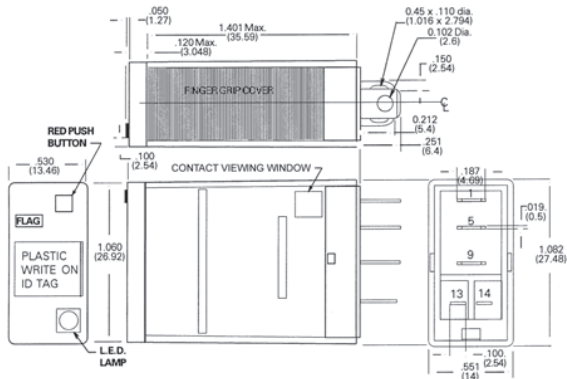

3TX7111 DPDT

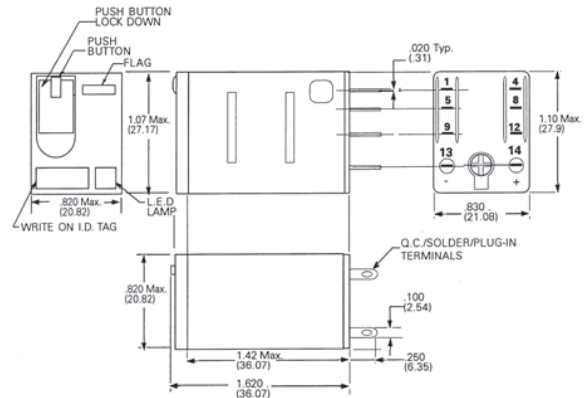

3TX7111 4PDT

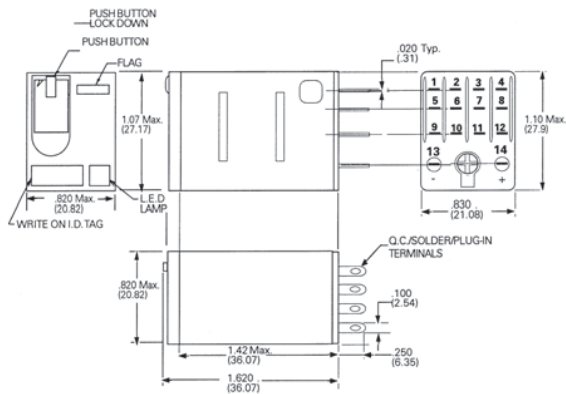

3TX7112 DPDT

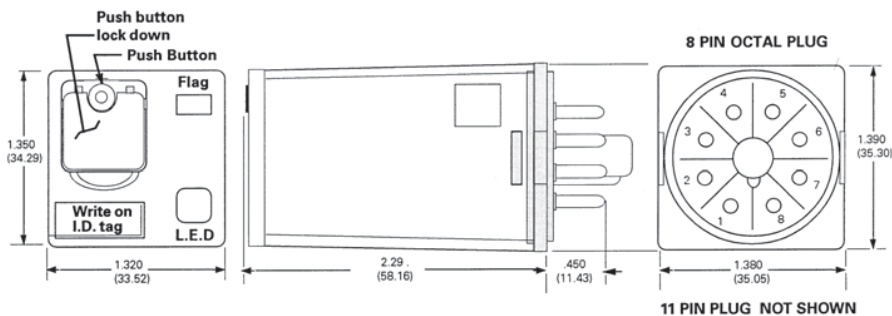

Function Relays, Interfaces and Converters

Coupling Relays and Interfaces

SIRIUS
RELAYS

3TX71 plug-in relays

Dimension drawings

3TX7114 DPDT

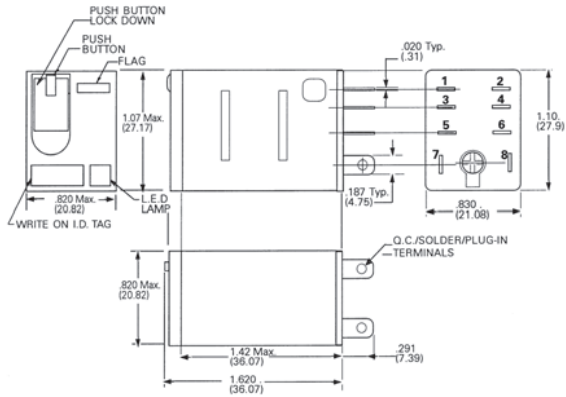

3TX7115 (DPDT) (clear cover)

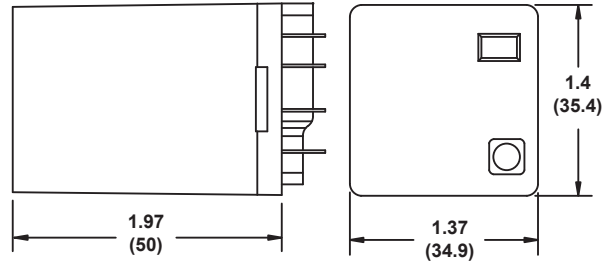

3TX7115 (DPDT) (full feature)

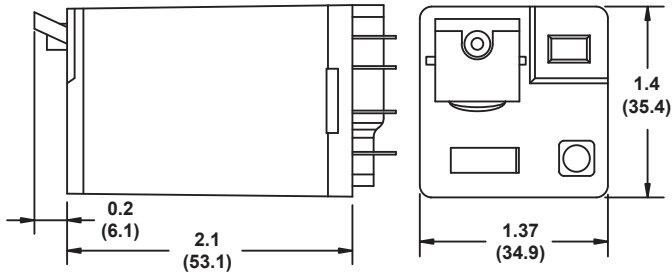

3TX7115 3PDT

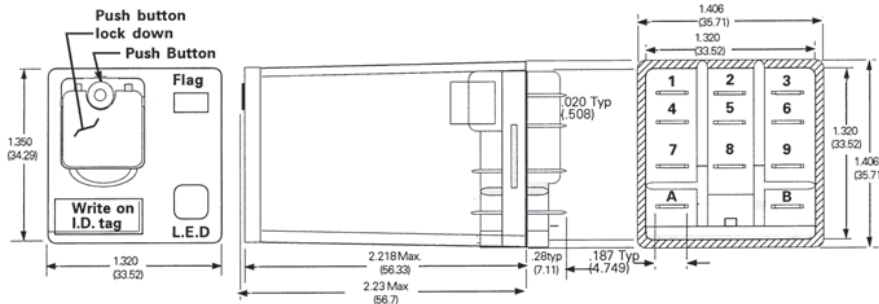

3TX7116 3PDT

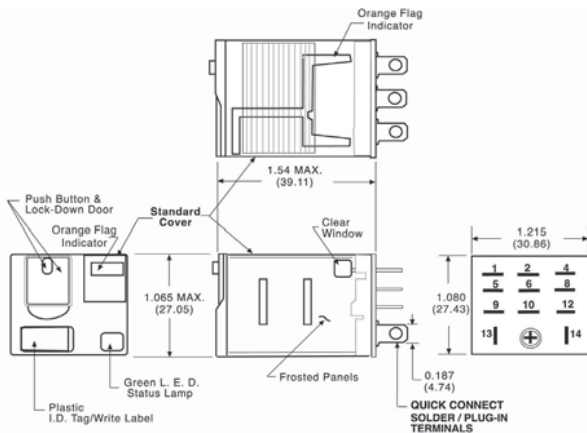

3TX7117 4PDT

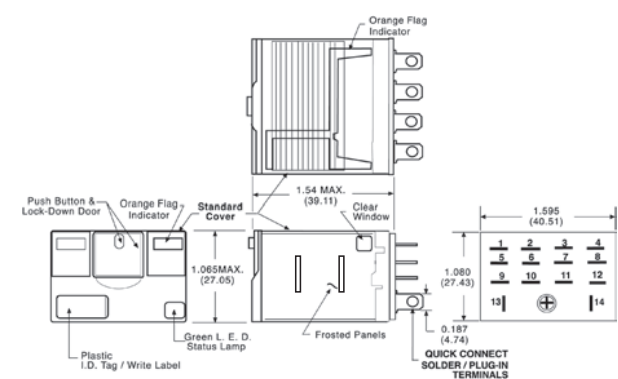

SIRIUS RELAYS

3TX71 plug-in relays

1

2

3

4

5

6

7

8

9

10

11

Dimension drawings

3TX7119 DPDT

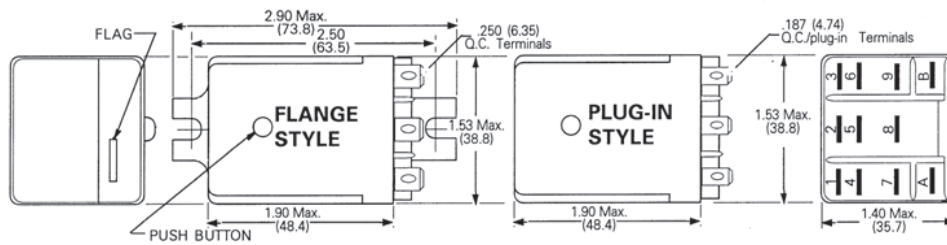

3TX7119 (3PDT)

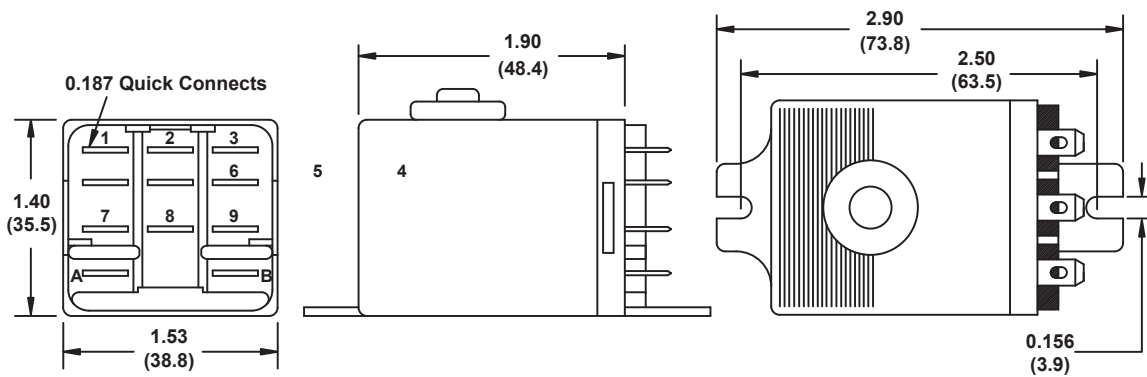

3TX7120

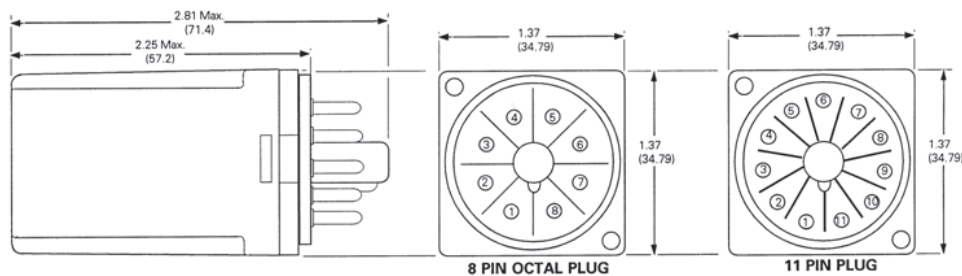

3TX7121/3TX7122

3TX7123

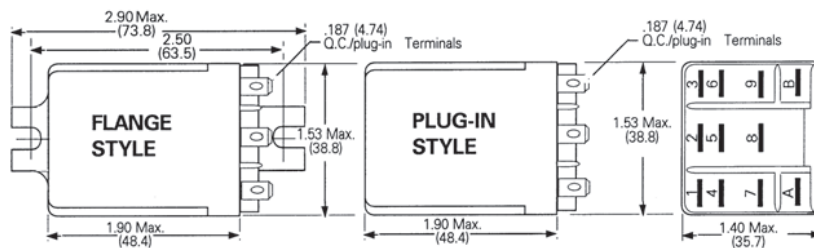

Function Relays, Interfaces and Converters

Coupling Relays and Interfaces

SIRIUS
RELAYS

• Revised •
12/10/14

3TX71 plug-in relays

Dimension drawings

3TX7123

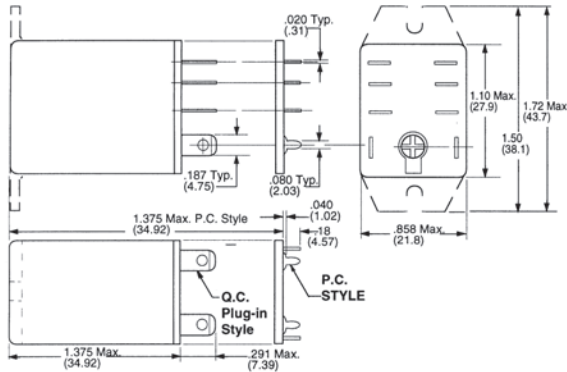

3TX7126

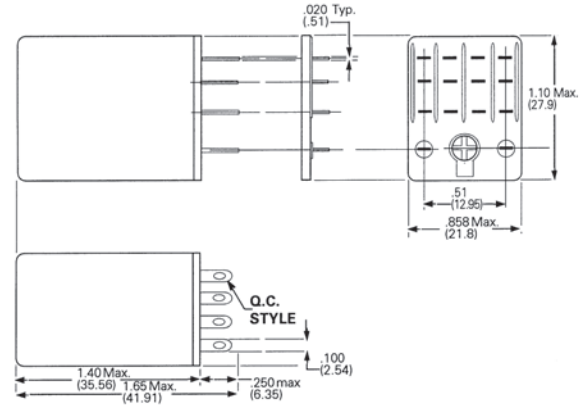

3TX7127 (DPDT)

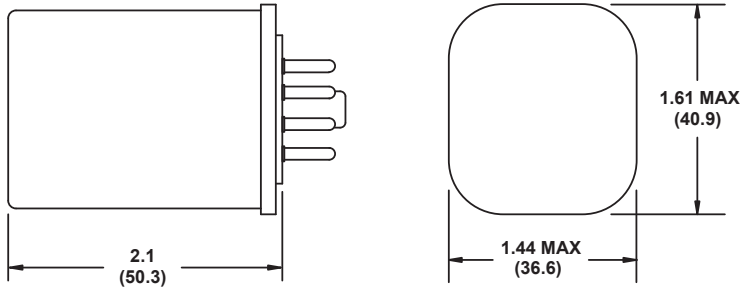

3TX7127 3PDT

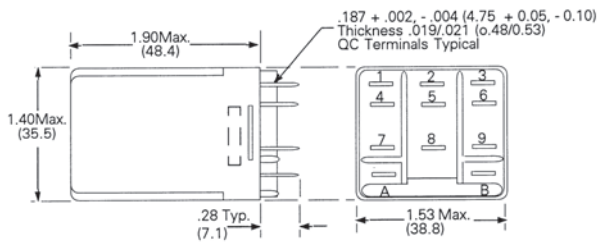

3TX7127 4PDT

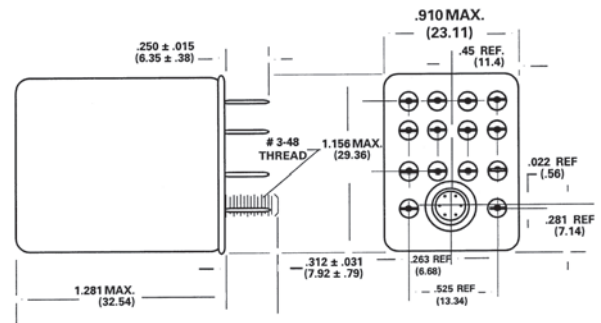

3TX7130 SPST NC

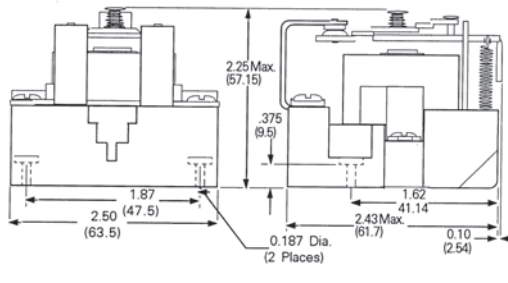

3TX7130 SPST NO

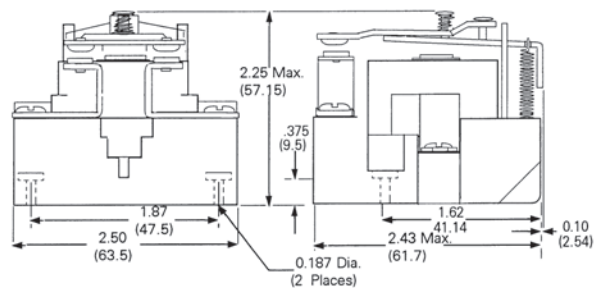

SIRIUS RELAYS

3TX71 plug-in relays

1

2

3

4

5

6

7

8

9

10

11

Dimension drawings

3TX7130 SPDT

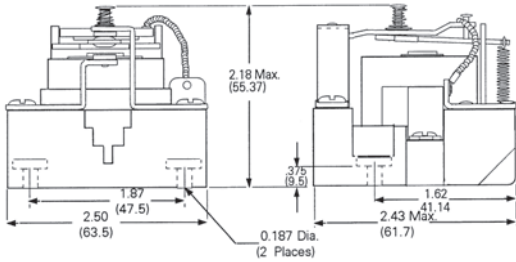

3TX7130 DPST NO

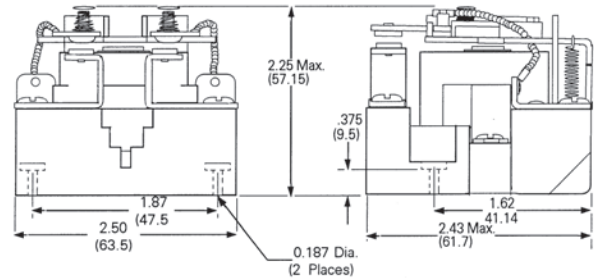

3TX7130 DPDT

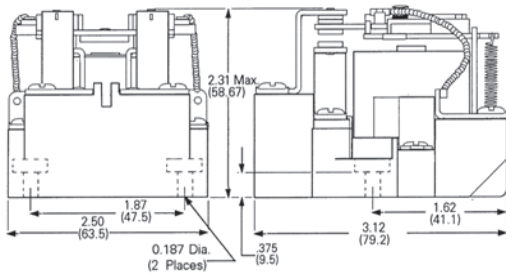

3TX7130 DPDT with magnetic
blowout

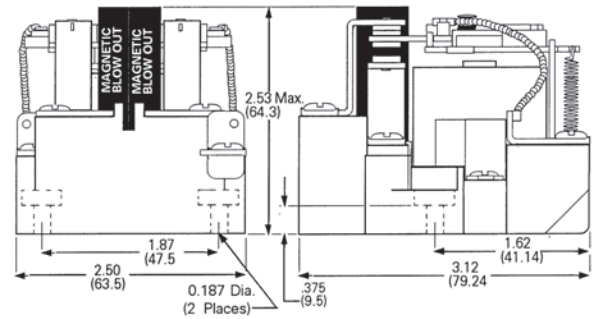

3TX7131 (DPST-NO)

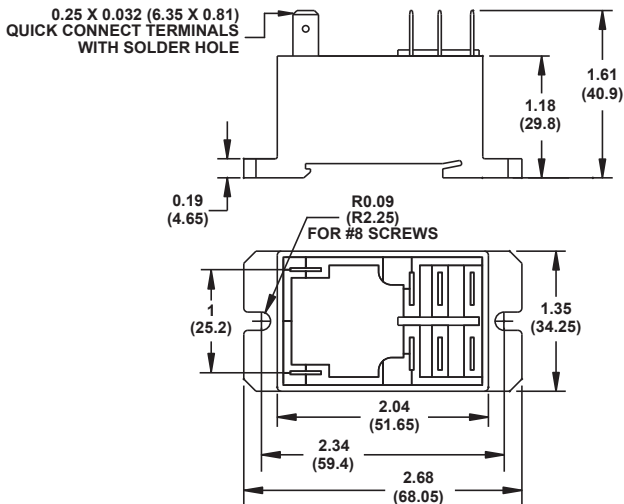

3TX7131 (DPDT)

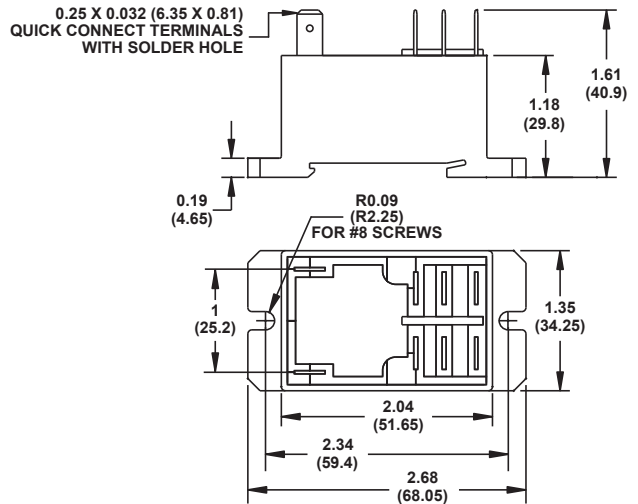

3TX71 plug-in relays

Dimension drawings

3TX7136

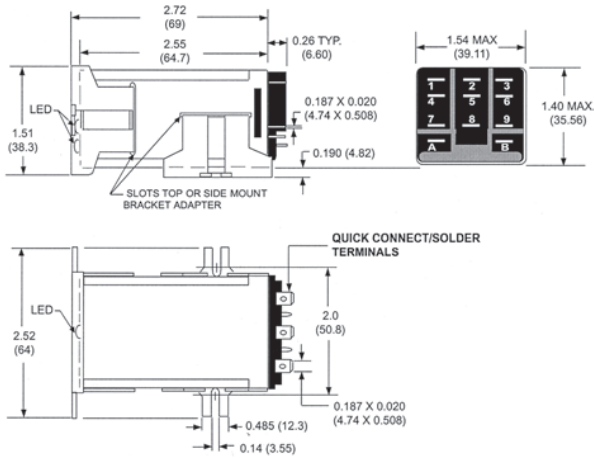

3TX7136 (DPDT Alternating)

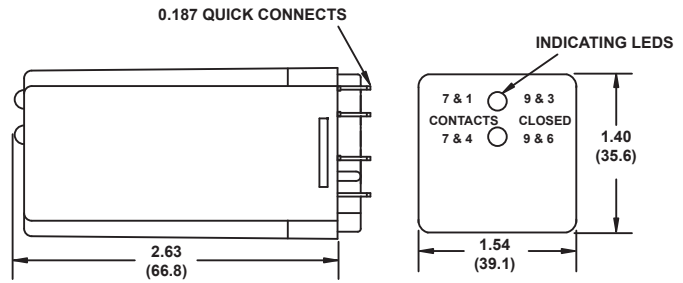

3TX7137 (DPDT)

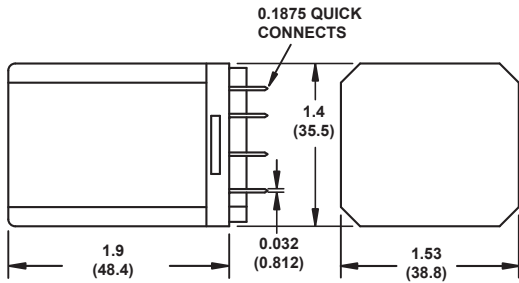

3TX7144-1E2

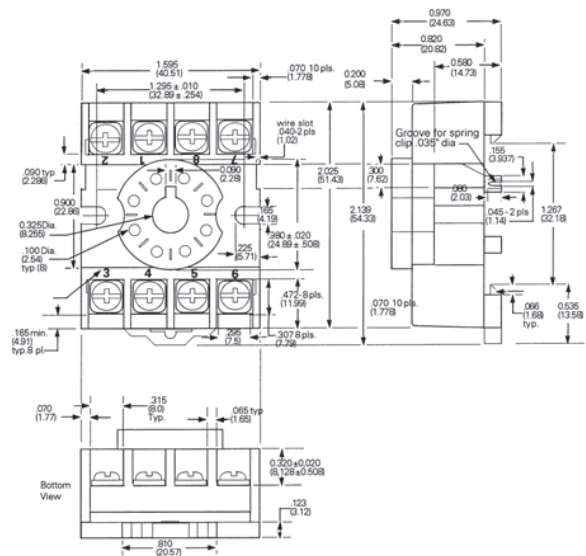

3TX7144-1E3

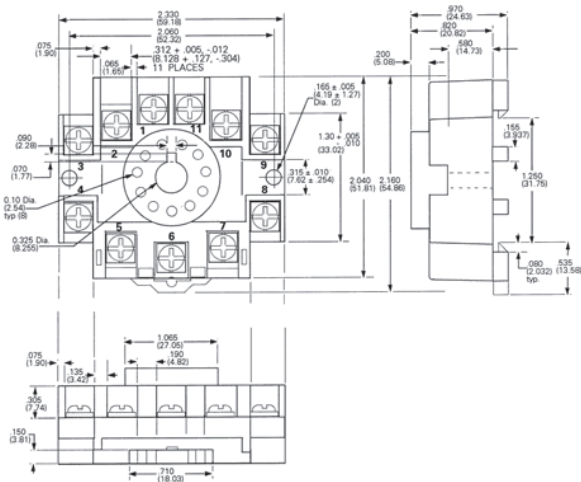

3TX7144-1E4

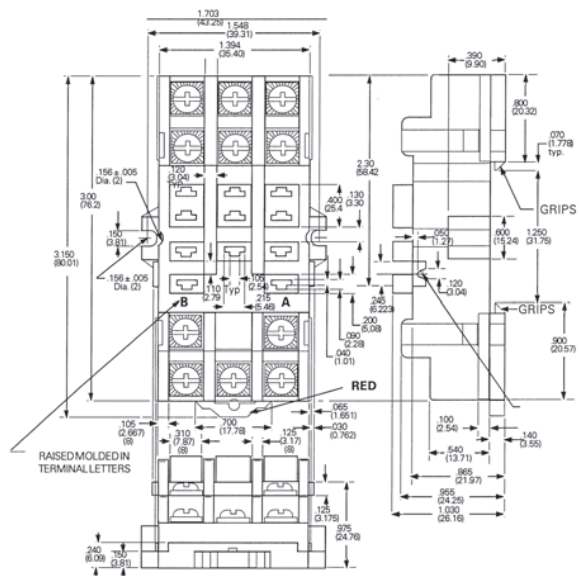

Dimension drawings

3TX7144-1E5

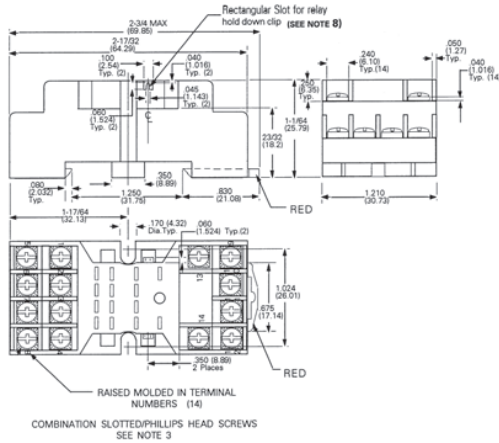

3TX7144-1E6

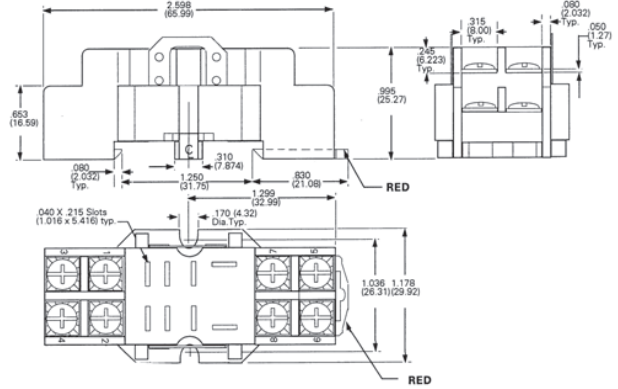

3TX7144-1E7

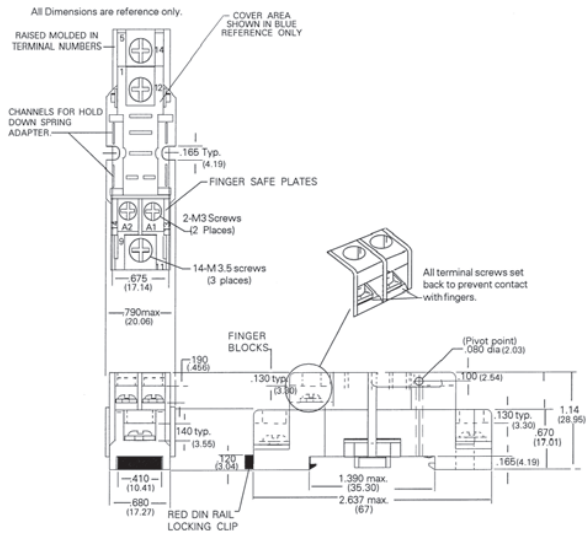

3TX7144-4E1

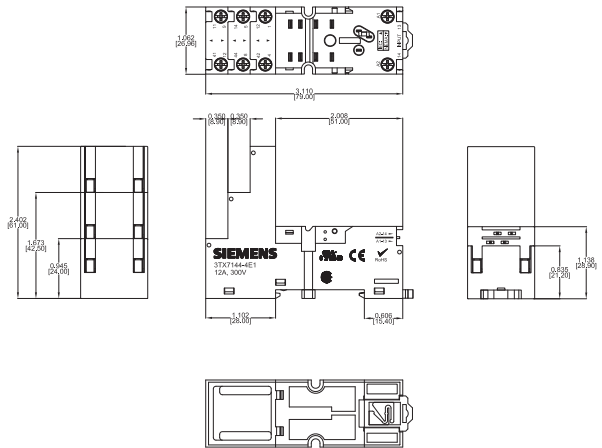

3TX7144-4E2

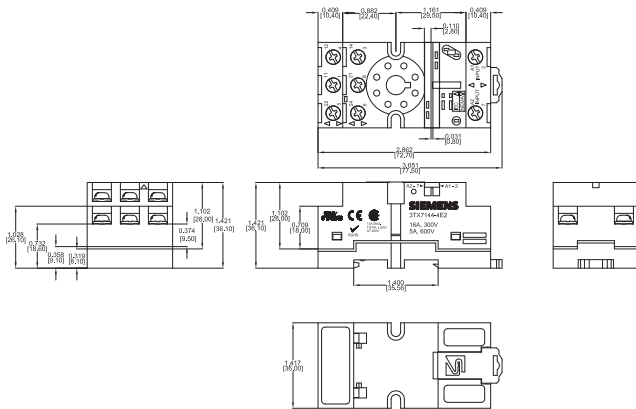

3TX7144-4E3

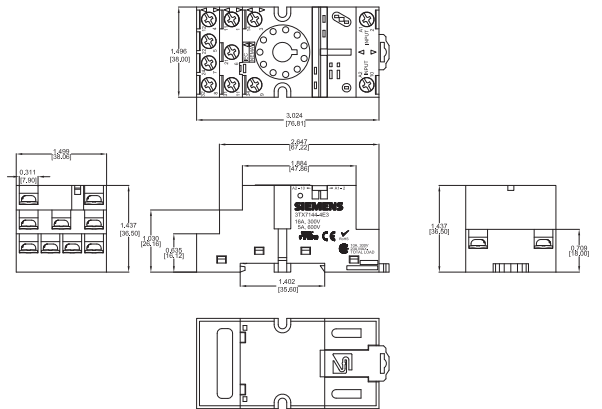

3TX71 plug-in relays

Dimension drawings

3TX7144-4E4

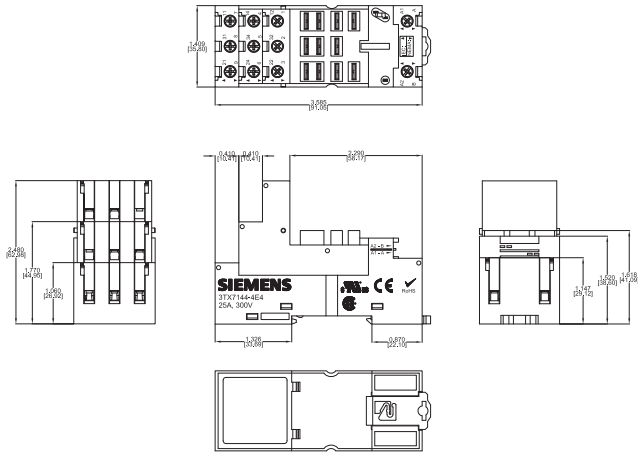

3TX7144-4E5

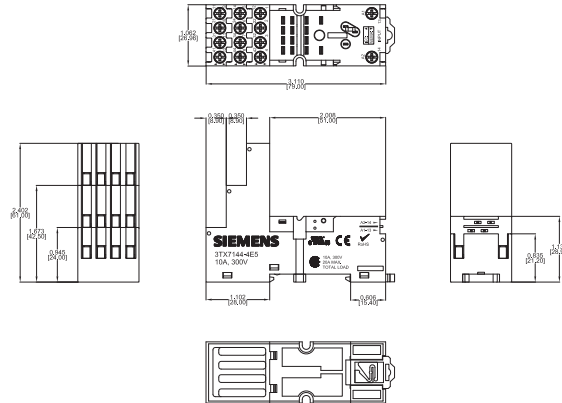

3TX7144-4E6

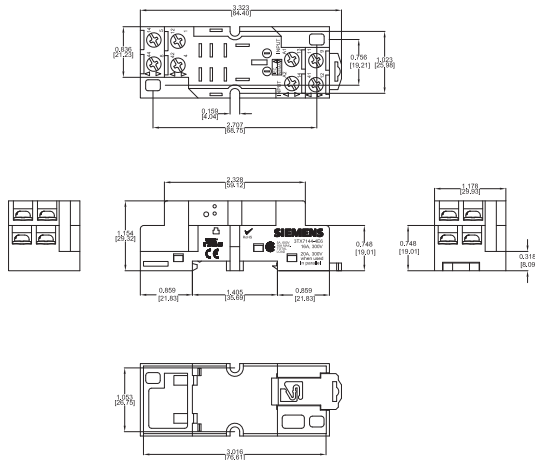

3TX7144-4E7

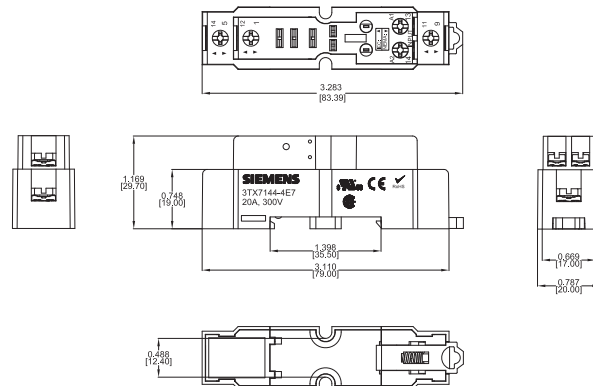

3TX7144-4E8

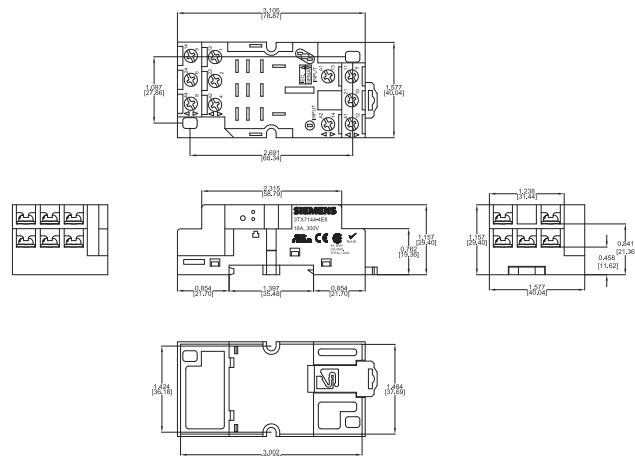

3TX7144-4E9

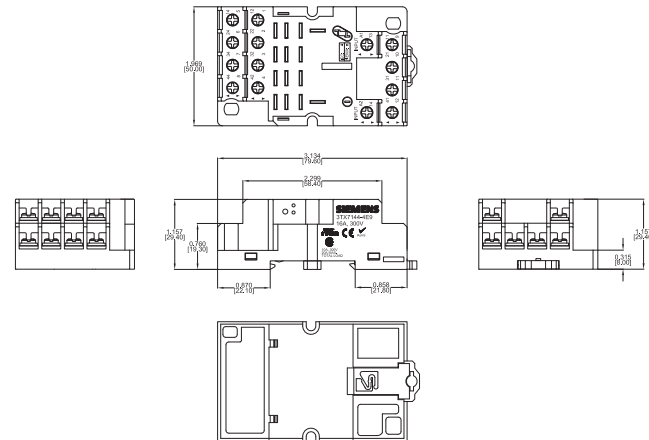

Dimension drawings

OFD-DFOB (DPDT)

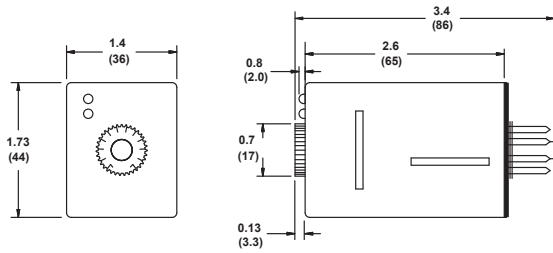

OND-DFOB (DPDT)

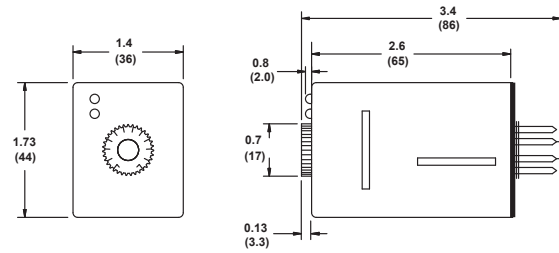

OFD-DFSB (DPDT)

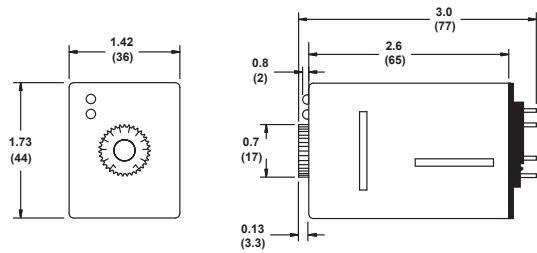

OND-DFSB (DPDT)

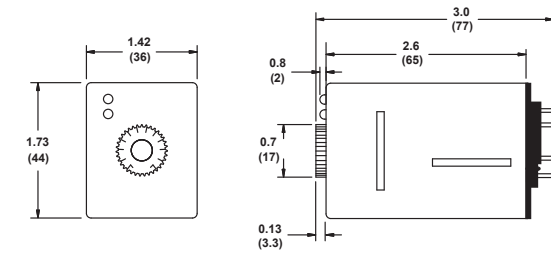

OFD-DFPR-00 (DPDT)

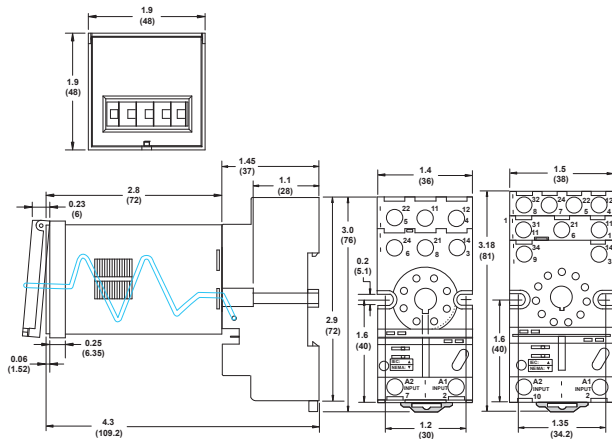

OND-DFPR-01 (SPDT)

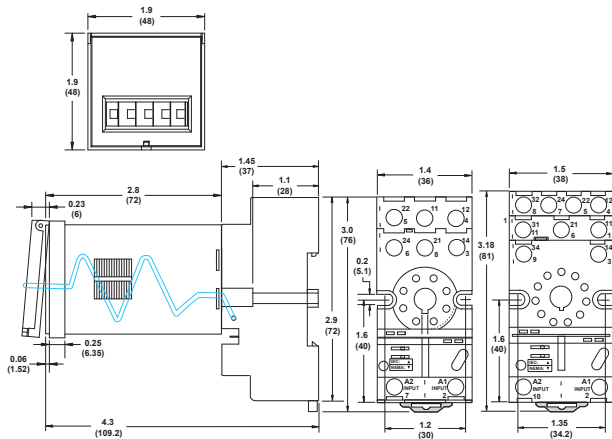

OND-DFPR-02 (DPDT)

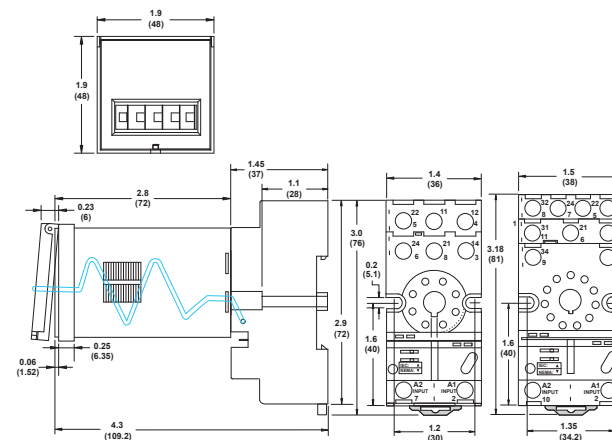

Function Relays, Interfaces and Converters

Coupling Relays and Interfaces

SIRIUS RELAYS

3TX71 plug-in relays

Circuit diagrams

3TX7110

SPDT

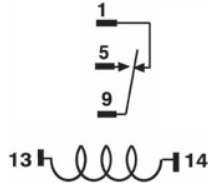

3TX7111

DPDT

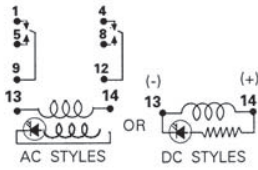

3TX7111

4PDT

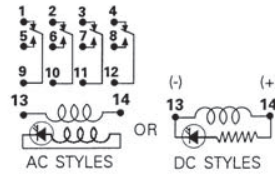

3TX7114

DPDT

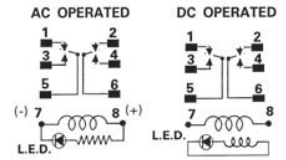

3TX7116

3PDT

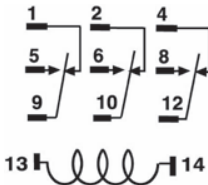

3TX7117

4PDT

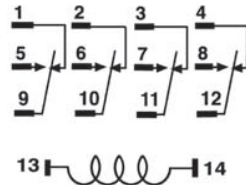

3TX7126/3TX7127

4PDT

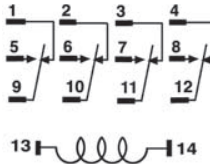

3TX7112

DPDT

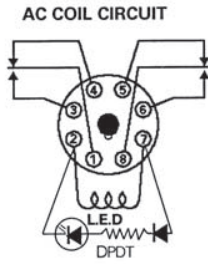

3TX7112

3PDT

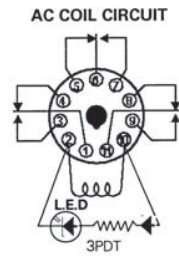

3TX7112-1L, -1D

DPDT

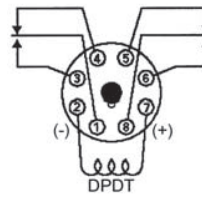

3TX7112-1N, -1F

3PDT

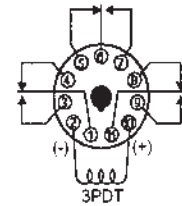

DC COIL CIRCUIT

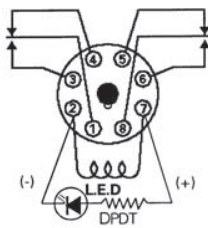

DC COIL CIRCUIT

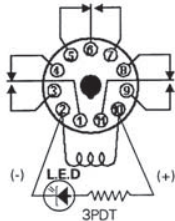

Bracketed values: Socket designations.
Without brackets: Contact/coil designations.

Circuit diagrams

3TX7130
SPST-NO



3TX7130
SPDT

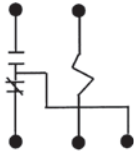

3TX7130
DPST-NO

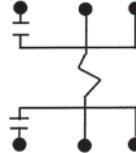

3TX7130
SPST-NC



SPST-NC-DB

3TX7130
DPDT

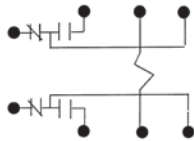

3TX7121
DPDT, 3PDT

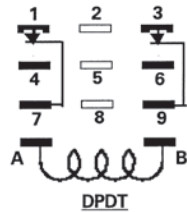

3TX7115
DPDT

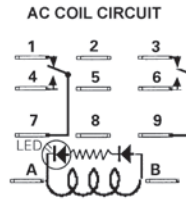

3TX7115
3PDT

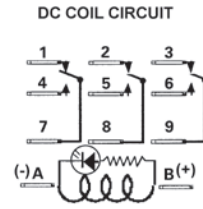
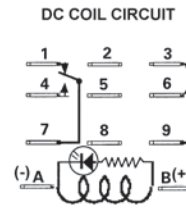
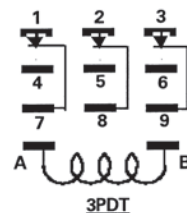
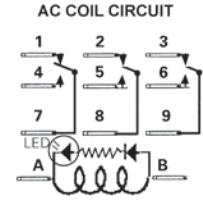

3TX7113
DPDT, 3PST, 3PDT

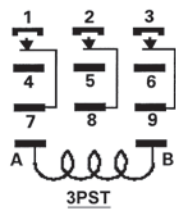

3TX7125
DPDT

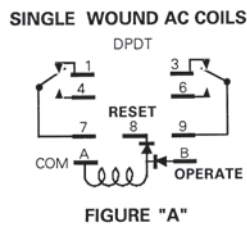

3TX7136
DPDT

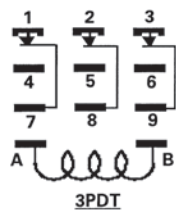
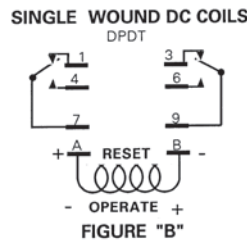
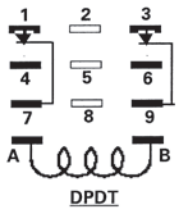
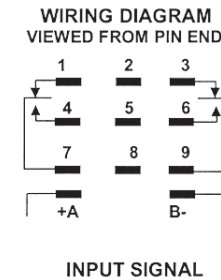

3TX71 plug-in relays

Dimension drawings

3TX7110

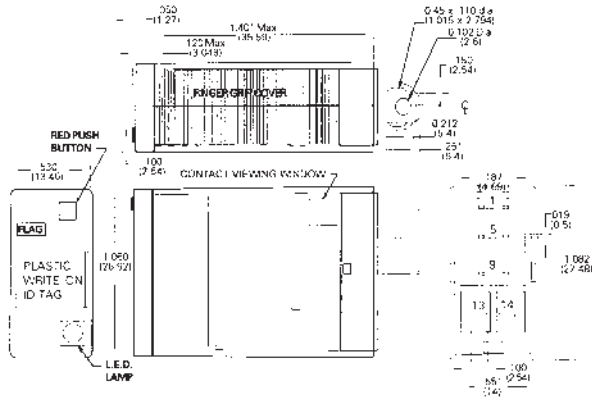

3TX7111 DPDT

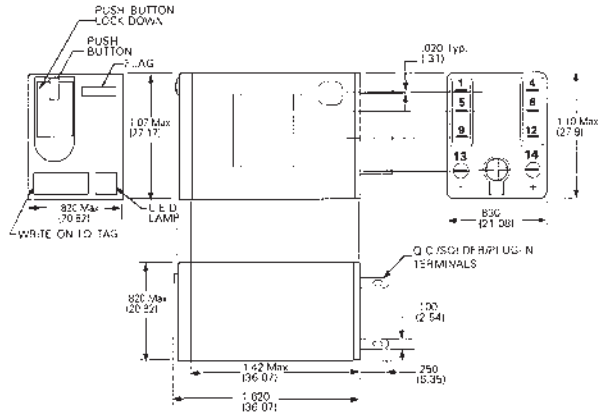

3TX7111 4PDT

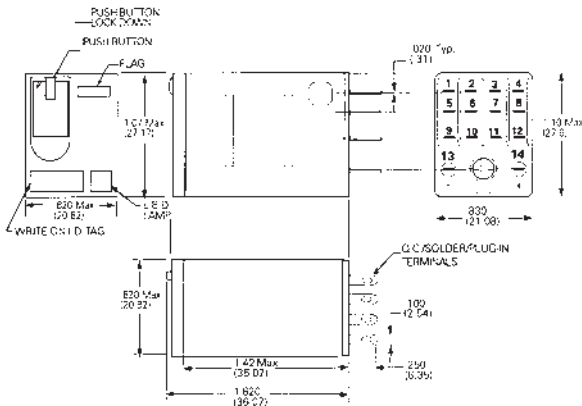

3TX7114

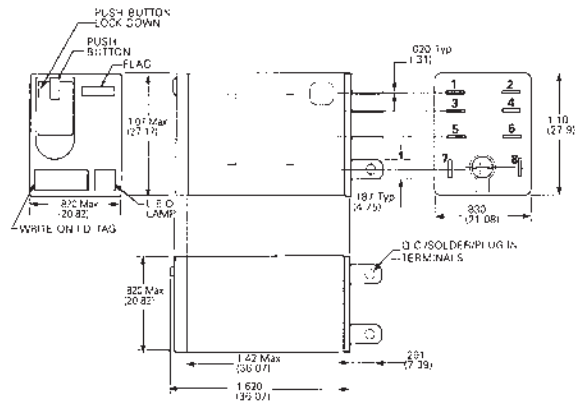

3TX7144-1E7

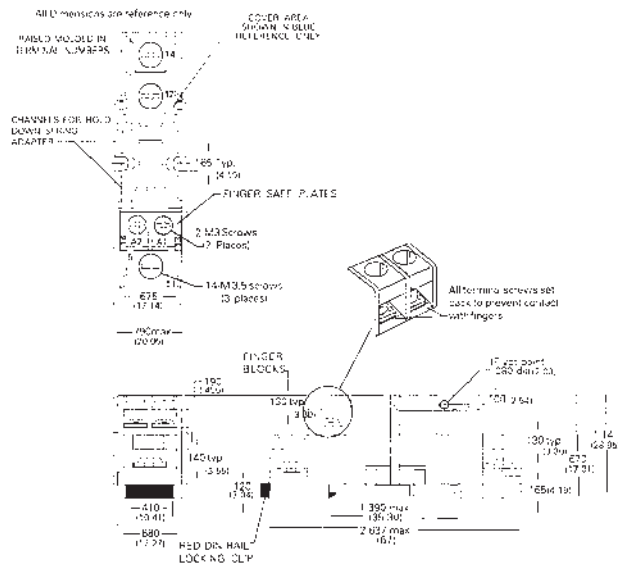

3TX7144-1E5

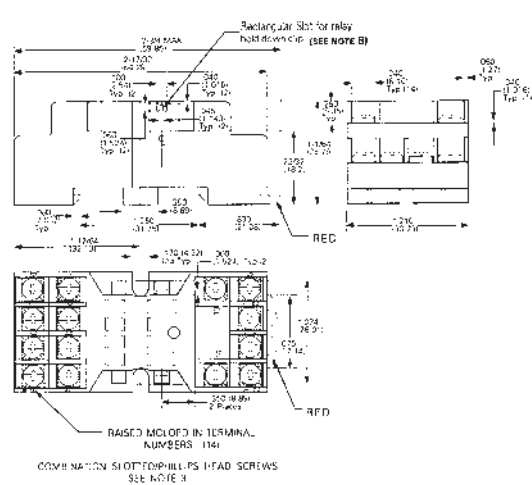



Dimension drawings

3TX7116

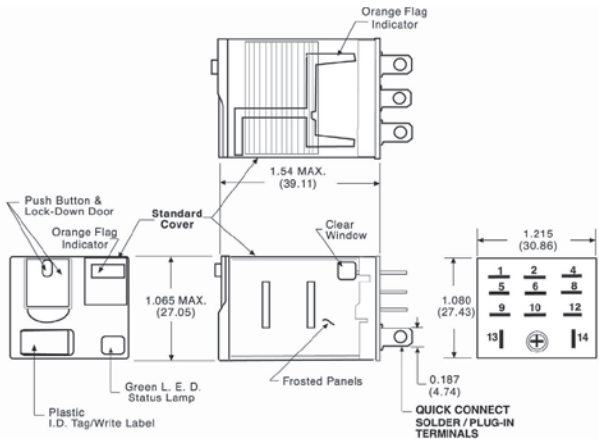

3TX7117

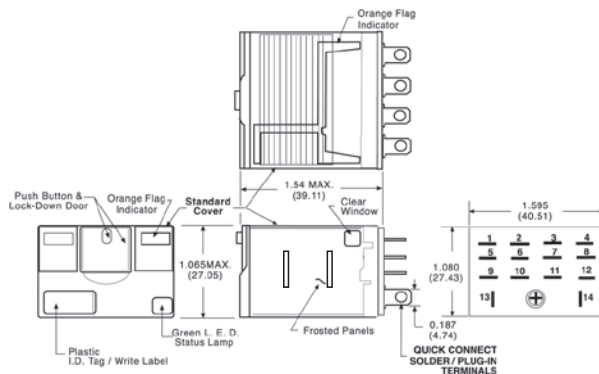

3TX7144-1E6

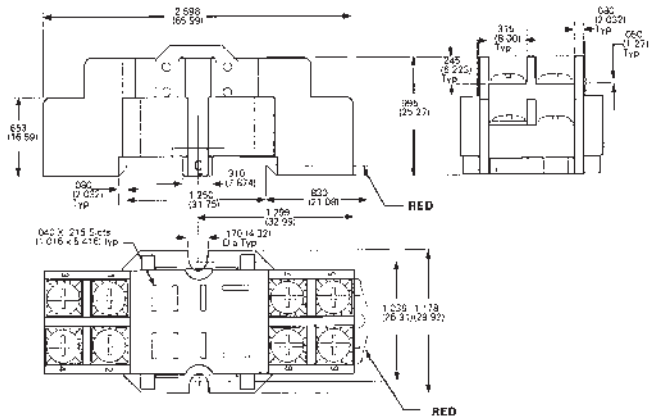

3TX7126

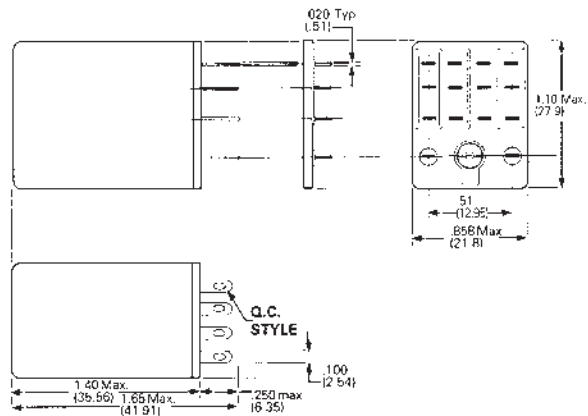

3TX7127

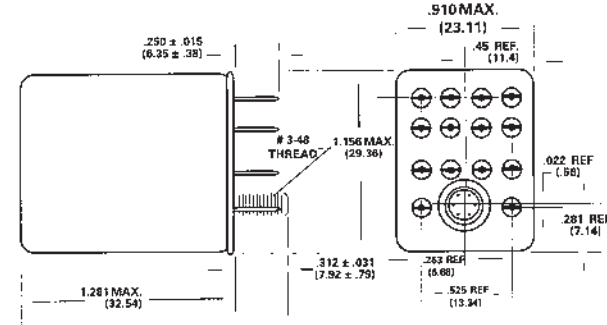

3TX7123

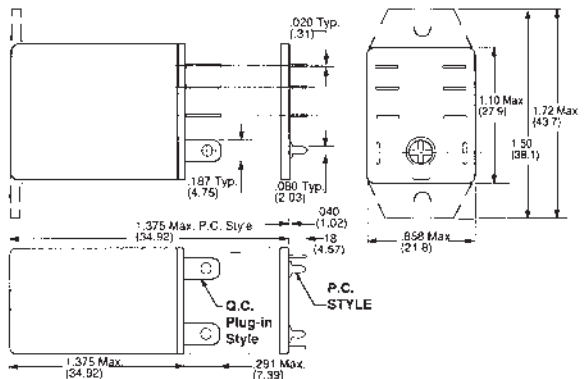

3TX71 plug-in relays

Dimension drawings

3TX7112

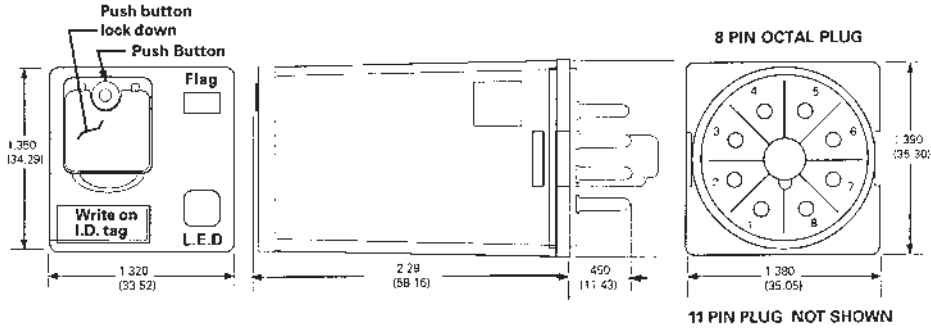

3TX7120

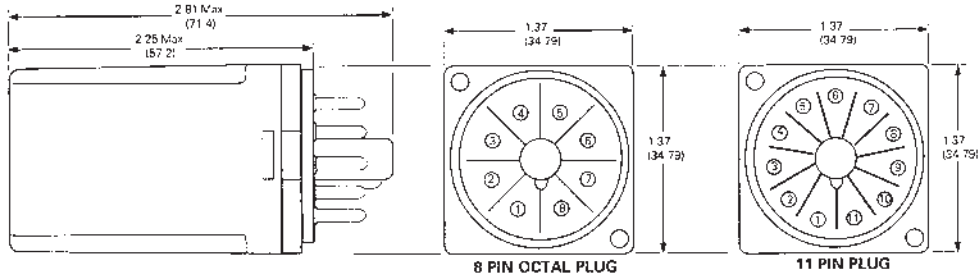

3TX7144-1E2

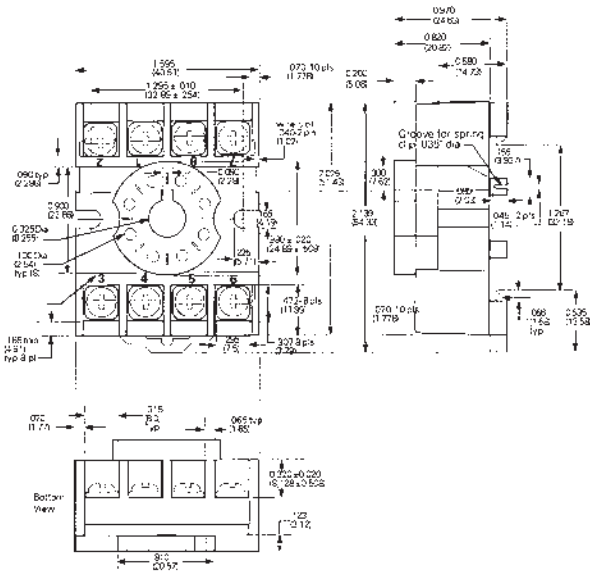

3TX7144-1E3

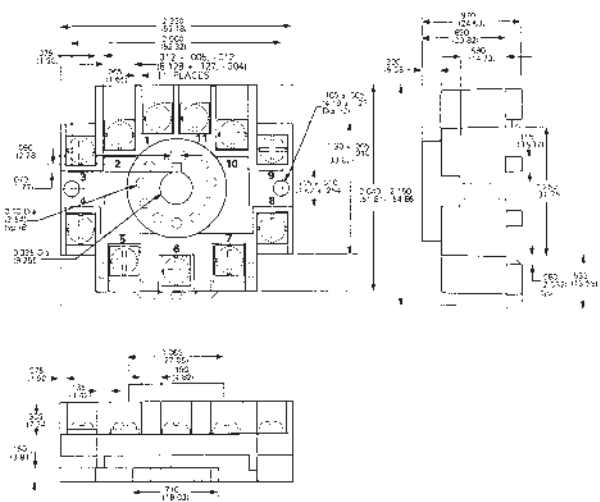

Dimension drawings

3TX7115

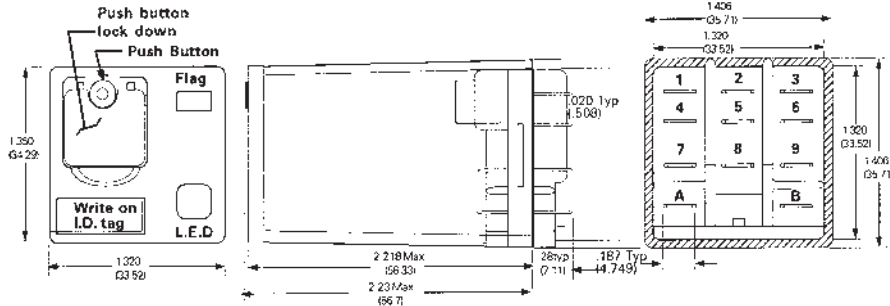

3TX7119

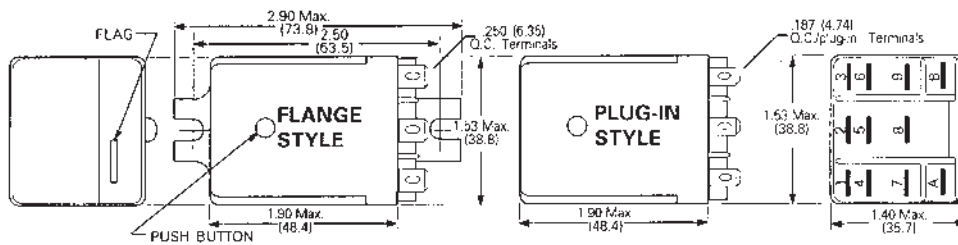

3TX7121/3TX7122

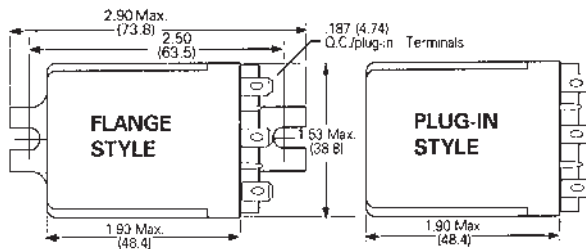

3TX7123

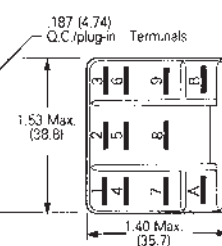

3TX7127

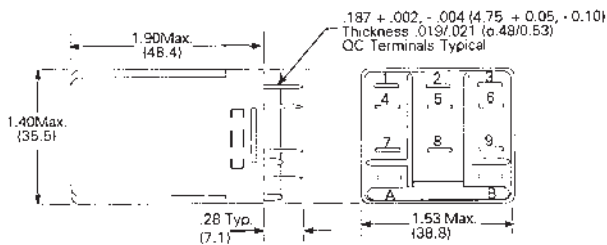

3TX7144-1E4

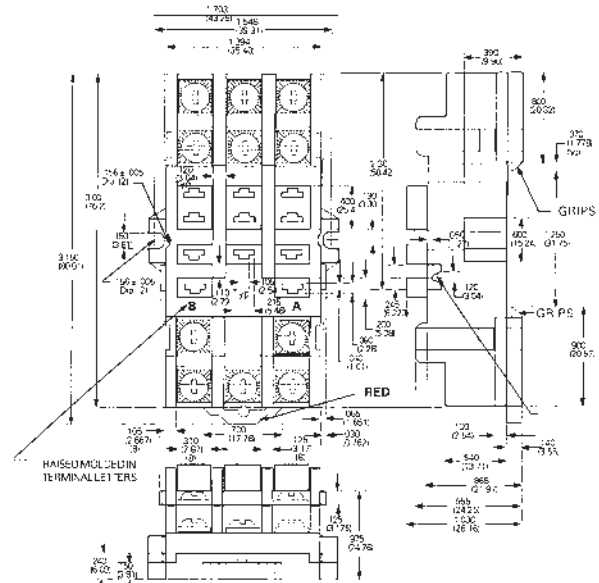

3TX71 plug-in relays

Dimension drawings

3TX7130 SPST NC

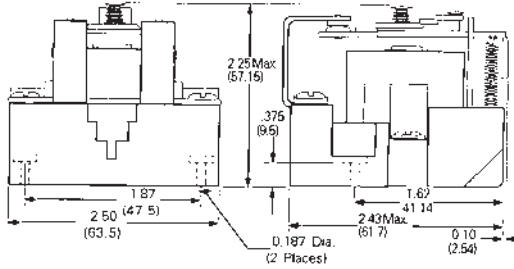

3TX7130 SPST NO

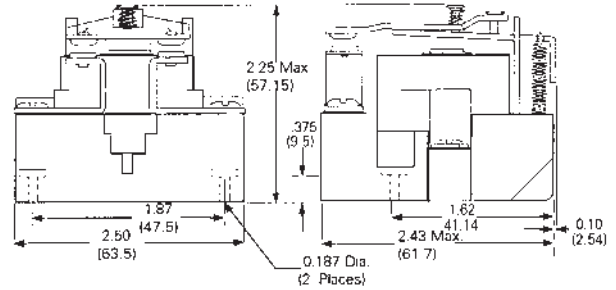

3TX7130 SPDT

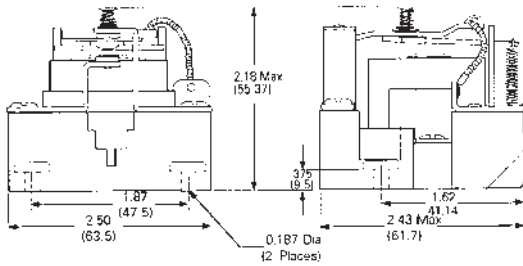

3TX7130 DPST NO

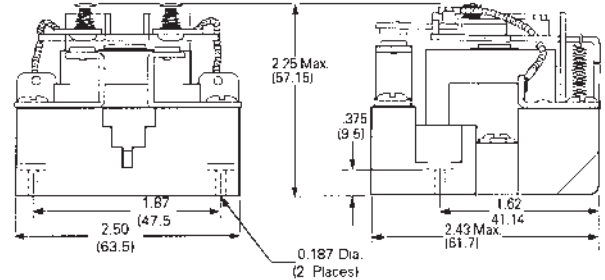

3TX7130 DPDT

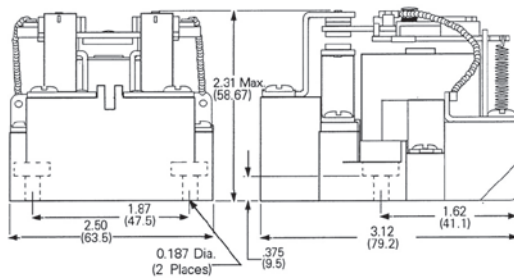

3TX7130 DPDT with magnetic
blowout

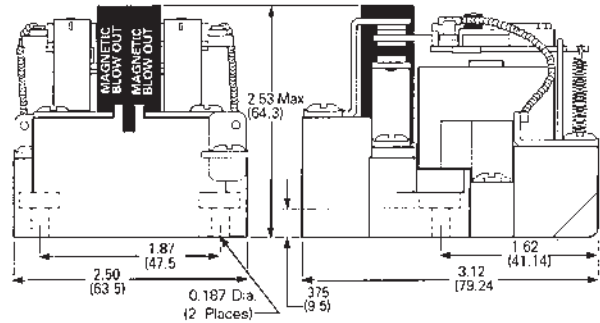

3TX7136

