

Photoelectric Sensors Theory of Operation

A photoelectric sensor is another type of position sensing device. Photoelectric sensors, similar to the ones shown below, use a modulated light beam that is either broken or reflected by the target.

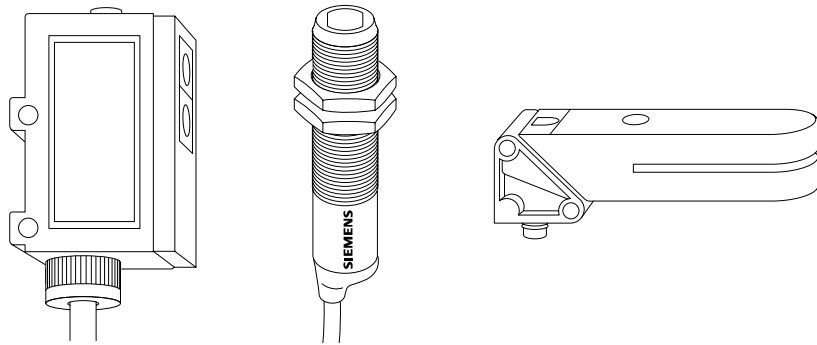

The control consists of an emitter (light source), a receiver to detect the emitted light, and associated electronics that evaluate and amplify the detected signal causing the photoelectric's output switch to change state. We are all familiar with the simple application of a photoelectric sensor placed in the entrance of a store to alert the presence of a customer. This, of course, is only one possible application.

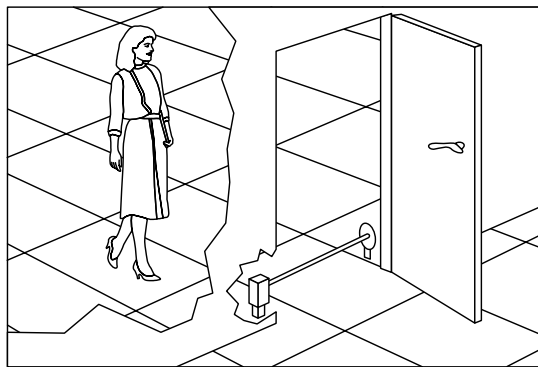

Modulated Light

Modulated light increases the sensing range while reducing the effect of ambient light. Modulated light is pulsed at a specific frequency between 5 and 30 KHz. The photoelectric sensor is able to distinguish the modulated light from ambient light. Light sources used by these sensors range in the light spectrum from visible green to invisible infrared. Light-emitting diode (LED) sources are typically used.

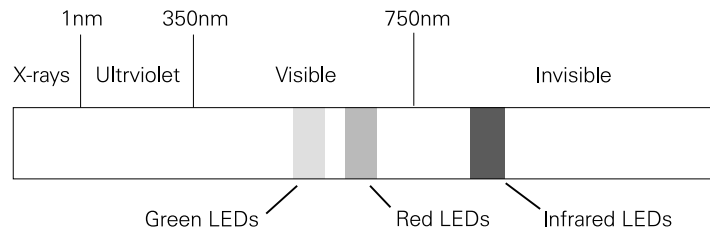

Clearance

It is possible that two photoelectric devices operating in close proximity to each other can cause interference. The problem may be rectified with alignment or covers. The following clearances between sensors are given as a starting point. In some cases it may be necessary to increase the distance between sensors.

| Sensor Model | Distance |
|-----------------|----------|
| D4 mm / M5 | 50 mm |
| M12 | 250 mm |
| M18 | 250 mm |
| K31 | 250 mm |
| K30 | 500 mm |
| K40 | 750 mm |
| K80 | 500 mm |
| L18 | 150 mm |
| L50 (Diffuse) | 30 mm |
| L50 (Thru-Beam) | 80 mm |

Excess Gain

Many environments, particularly industrial applications, include dust, dirt, smoke, moisture, or other airborne contaminants. A sensor operating in an environment that contains these contaminants requires more light to operate properly. There are six grades of contamination:

1. Clean Air (Ideal condition, climate controlled or sterile)
2. Slight Contamination (Indoor, nonindustrial areas, office buildings)
3. Low Contamination (Warehouse, light industry, material handling operations)
4. Moderate Contamination (Milling operations, high humidity, steam)
5. High Contamination (Heavy particle laden air, extreme wash down environments, grain elevators)
6. Extreme/Severe Contamination (Coal bins, residue on lens)

Excess gain represents the amount of light emitted by the transmitter in excess of the amount required to operate the receiver. In clean environments an excess gain equal to or greater than 1 is usually sufficient to operate the sensor's receiver. If, for example, an environment contained enough airborne contaminants to absorb 50% of the light emitted by the transmitter, a minimum excess gain of 2 would be required to operate the sensor's receiver.

Excess gain is plotted on a logarithmic chart. The example shown below is an excess gain chart for an M12 thru-beam sensor. If the required sensing distance is 1 m there is an excess gain of 30. This means there is 30 times more light than required in clean air hitting the receiver. Excess gain decreases as sensing distance increases. Keep in mind that the sensing distance for thru-beam sensors is from the transmitter to the receiver and the sensing distance for reflective sensors is from the transmitter to the target.

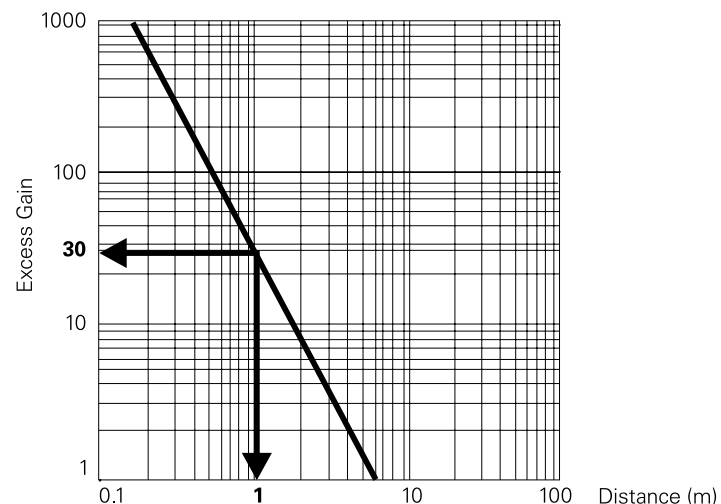

Switching Zones

Photoelectric sensors have a switching zone. The switching zone is based on the beam pattern and diameter of the light from the sensor's emitter. The receiver will operate when a target enters this area.

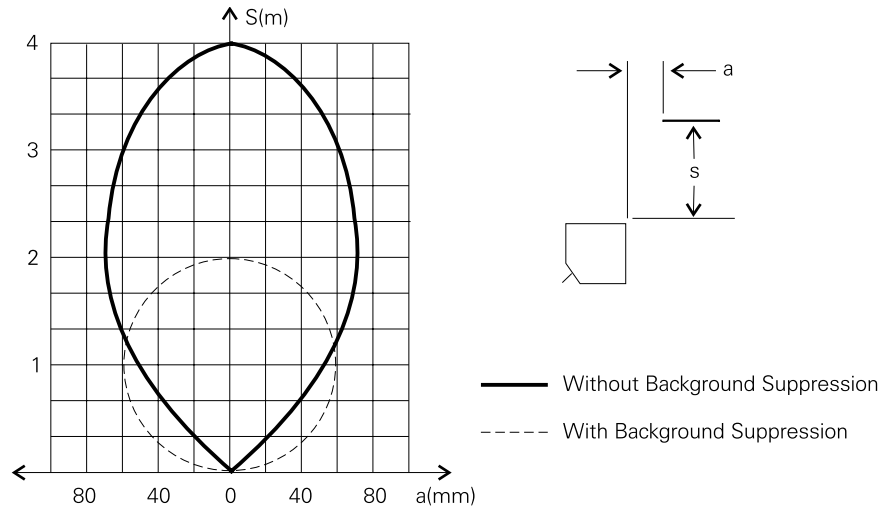

Symbols

Various symbols are used in the Sensor catalog (SFPC-08000) to help identify the type of photoelectric sensor. Some symbols are used to indicate a sensor's scan technique, such as diffuse, retroreflective, or thru beam. Other symbols identify a specific feature of the sensor, such as fiber-optics, slot, or color sensor.

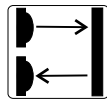

Diffuse Sensor

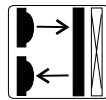

Diffuse Sensor with Background Suppression

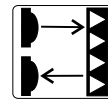

Retroreflective Sensor

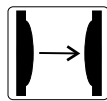

Thru-Beam Sensor

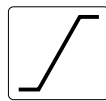

Diffuse Sensor with Analog Output



Sensors for Fiber-Optic Conductors

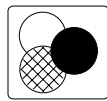

Color Sensor

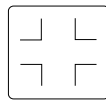

Color Mark Sensor

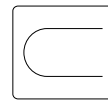

Slot Sensor

Scan Techniques

A scan technique is a method used by photoelectric sensors to detect an object (target). In part, the best technique to use depends on the target. Some targets are opaque and others are highly reflective. In some cases it is necessary to detect a change in color. Scanning distance is also a factor in selecting a scan technique. Some techniques work well at greater distances while others work better when the target is closer to the sensor.

Thru-Beam

Separate emitter and receiver units are required for a thru-beam sensor. The units are aligned in a way that the greatest possible amount of pulsed light from the transmitter reaches the receiver. An object (target) placed in the path of the light beam blocks the light to the receiver, causing the receiver's output to change state. When the target no longer blocks the light path the receiver's output returns to its normal state.

Thru-beam is suitable for detection of opaque or reflective objects. It cannot be used to detect transparent objects. In addition, vibration can cause alignment problems. The high excess gain of thru-beam sensors make them suitable for environments with airborne contaminants. The maximum sensing range is 300 feet.

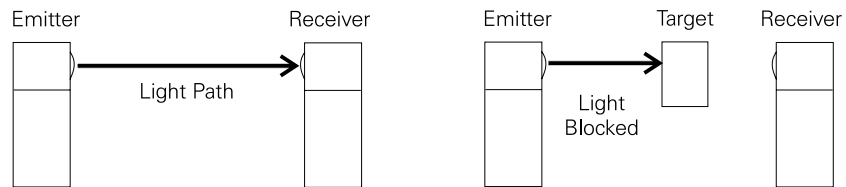

Thru-Beam Effective Beam

The effective beam of a photoelectric sensor is the region of the beam's diameter where a target is detected. The effective beam on a thru-beam sensor is the diameter of the emitter and receiver lens. The effective beam extends from the emitter lens to the receiver lens. The minimum size of the target should equal the diameter of the lens.

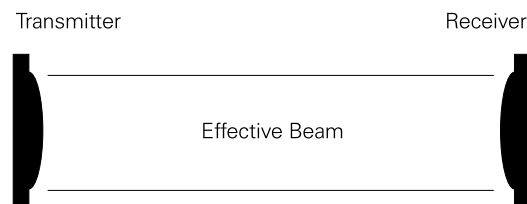

Reflective or Retroreflective Scan

Reflective and retroreflective scan are two names for the same technique. The emitter and receiver are in one unit. Light from the emitter is transmitted in a straight line to a reflector and returns to the receiver. A normal or a corner-cube reflector can be used. When a target blocks the light path the output of the sensor changes state. When the target no longer blocks the light path the sensor returns to its normal state. The maximum sensing range is 35 feet.

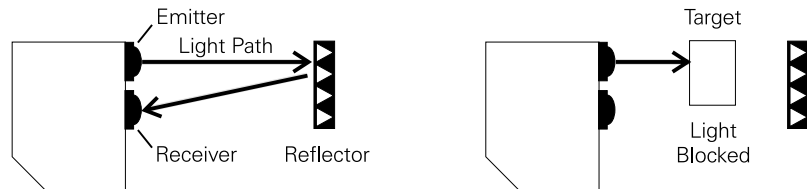

Retroreflective Scan Effective Beam

The effective beam is tapered from the sensor's lens to the edges of the reflector. The minimum size of the target should equal the size of the reflector.

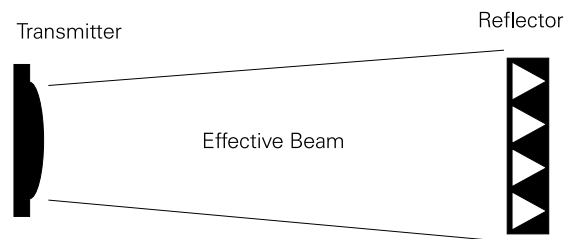

Reflectors

Reflectors are ordered separately from sensors. Reflectors come in various sizes and can be round or rectangular in shape or reflective tape. The sensing distance is specified with a particular reflector. Reflective tape should not be used with polarized retroreflective sensors.

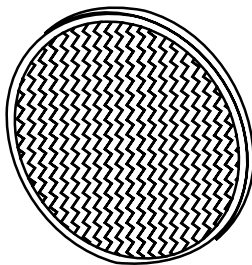

Retroreflective Scan and Shiny Objects

Retroreflective scan sensors may not be able to detect shiny objects. Shiny objects reflect light back to the sensor. The sensor is unable to differentiate between light reflected from a shiny object and light reflected from a reflector.

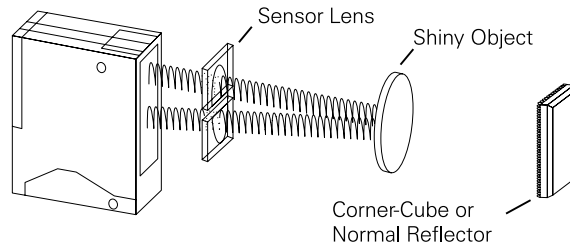

Polarized Retroreflective Scan

A variation of retroreflective scan is polarized retroreflective scan. Polarizing filters are placed in front of the emitter and receiver lenses. The polarizing filter projects the emitter's beam in one plane only. This light is said to be polarized. A corner-cube reflector must be used to rotate the light reflected back to the receiver. The polarizing filter on the receiver allows rotated light to pass through to the receiver. In comparison to retroreflective scan, polarized retroreflective scan works well when trying to detect shiny objects.

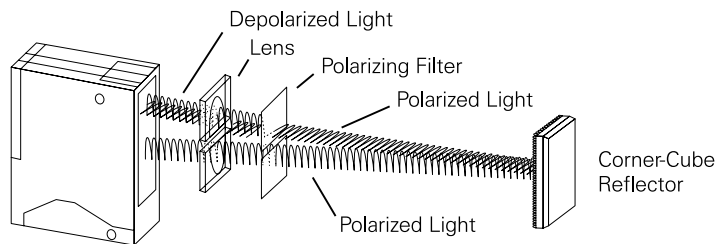

Diffuse Scan

The emitter and receiver are in one unit. Light from the emitter strikes the target and the reflected light is diffused from the surface at all angles. If the receiver receives enough reflected light the output will switch states. When no light is reflected back to the receiver the output returns to its original state. In diffuse scanning the emitter is placed perpendicular to the target. The receiver will be at some angle in order to receive some of the scattered (diffuse) reflection. Only a small amount of light will reach the receiver, therefore, this technique has an effective range of about 40"

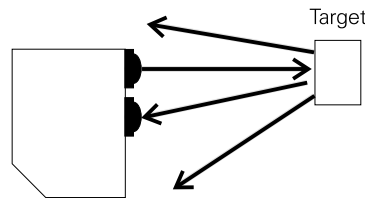

Diffuse Scan Correction Factors

The specified sensing range of diffuse sensors is achieved by using a matte white paper. The following correction values may be applied to other surfaces. These values are guidelines only and some trial and error may be necessary to get correct operation.

| | |
|----------------------------------|------|
| Test Card (Matte White) | 100% |
| White Paper | 80% |
| Gray PVC | 57% |
| Printed Newspaper | 60% |
| Lightly Colored Wood | 73% |
| Cork | 65% |
| White Plastic | 70% |
| Black Plastic | 22% |
| Neoprene, Black | 20% |
| Automobile Tires | 15% |
| Aluminum, Untreated | 200% |
| Aluminum, Black Anodized | 150% |
| Aluminum, Matte (Brushed Finish) | 120% |
| Stainless Steel, Polished | 230% |

Diffuse Scan with Background Suppression

Diffuse scan with background suppression is used to detect objects up to a certain distance. Objects beyond the specified distance are ignored. Background suppression is accomplished with a position sensor detector (PSD). Reflected light from the target hits the PSD at different angles, depending on the distance of the target. The greater the distance the narrower the angle of the reflected light.

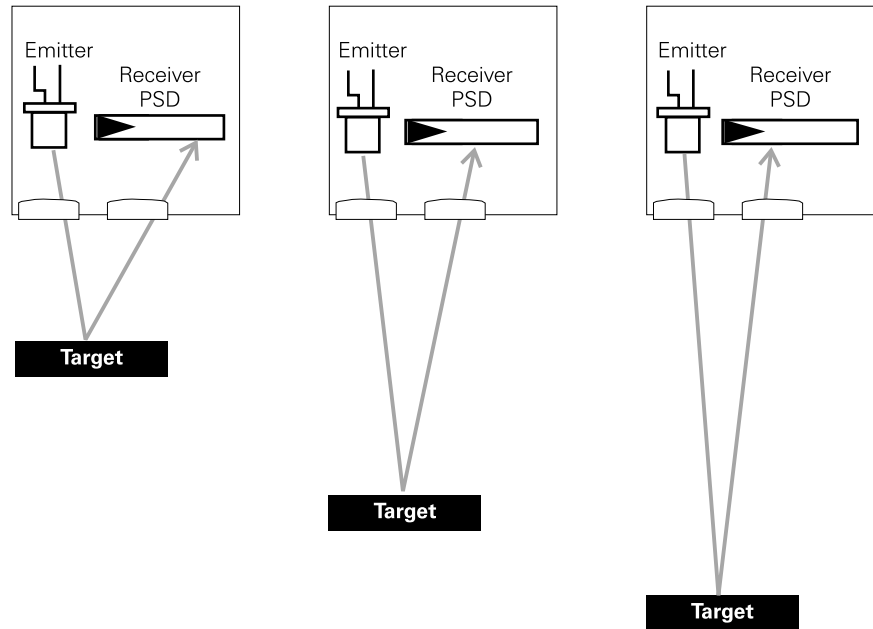

Diffuse Scan Effective Beam

The effective beam is equal to the size of the target when located in the beam pattern.

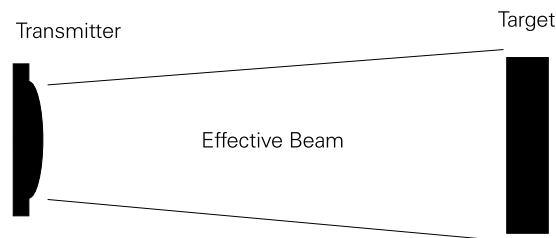

Operating Modes

There are two operating modes: dark operate (DO) and light operate (LO). Dark operate is an operating mode in which the load is energized when light from the emitter is absent from the receiver.

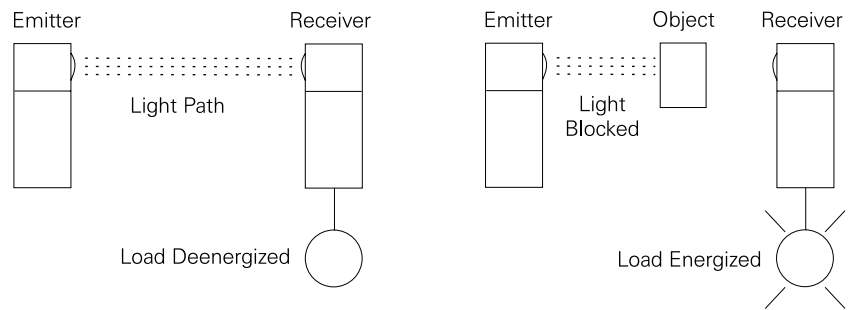

Light operate is an operating mode in which the load is energized when light from the emitter reaches the receiver.

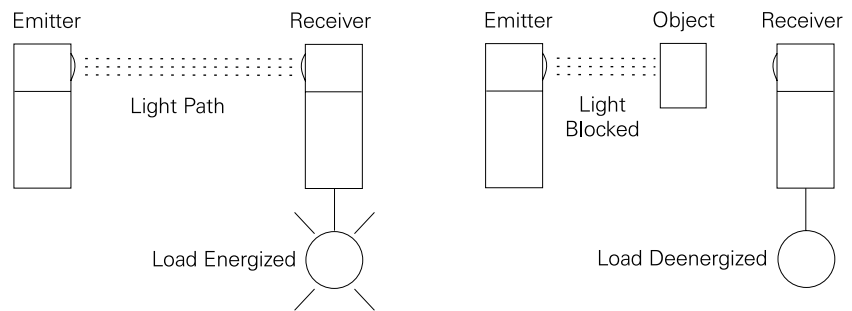

The following table shows the relationship between operating mode and load status for thru, retroreflective, and diffuse scan.

| Operating Mode | Light Path | Load Status | |
|--------------------|-------------|-------------------------------|-------------|
| | | Thru Scan and Retroreflective | Diffuse |
| Light Operate (LO) | Not Blocked | Energized | Deenergized |
| | Blocked | Deenergized | Energized |
| Dark Operate (DO) | Not Blocked | Deenergized | Energized |
| | Blocked | Energized | Deenergized |

Fiber Optics

Fiber optics is not a scan technique, but another method for transmitting light. Fiber optic sensors use an emitter, receiver, and a flexible cable packed with tiny fibers that transmit light. Depending on the sensor there may be a separate cable for the emitter and receiver, or it may use a single cable. When a single cable is used, the emitter and receiver use various methods to distribute emitter and transmitter fibers within a cable. Glass fibers are used when the emitter source is infrared light. Plastic fibers are used when the emitter source is visible light.

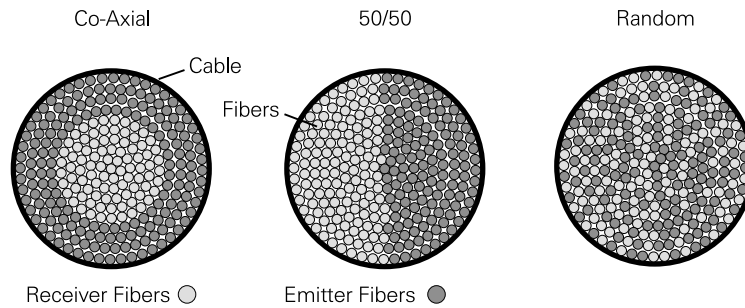

Fiber optics can be used with thru-beam, retroreflective scan, or diffuse scan sensors. In thru beam light is emitted and received with individual cables. In retroreflective and diffuse scan light is emitted and received with the same cable (bifurcated). Fiber optics is ideal for small sensing areas or small objects. Fiber optics have a shorter sensing range due to light losses in the fiber optic cables.

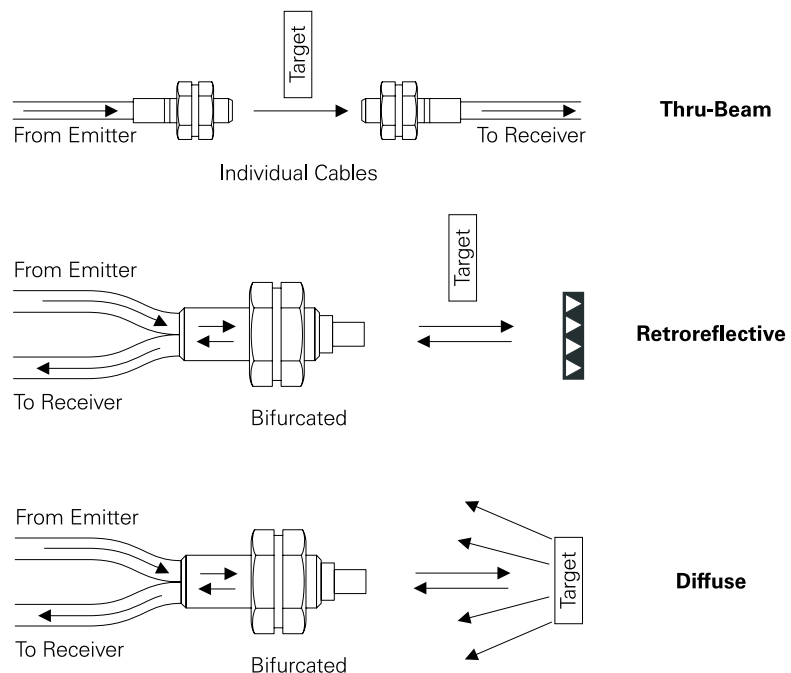

Lasers

Lasers are sometimes used as sensor light sources. Siemens uses Class 2 lasers which have a maximum radiant power of 1 mW. Class 2 lasers require no protective measures and a laser protection officer is not required. However, a warning notice must be displayed when laser sensors are used.

Laser sensors are available in thru-beam, diffuse scan, and diffuse scan with background suppression versions. Lasers have a high intensity visible light, which makes setup and adjustment easy. Laser technology allows for detection of extremely small objects at a distance. The Siemens L18 sensor, for example, will detect an object of 0.03 mm at a distance of 80 cm. Examples of laser sensor applications include exact positioning, speed detection, or checking thread thickness of 0.1 mm and over.

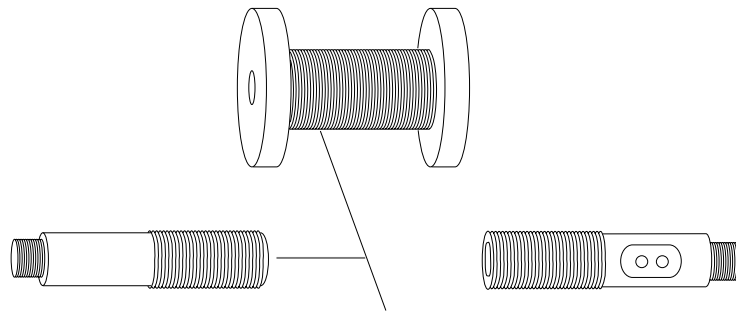

Review 7

- 1) Modulated light of a Siemens photoelectric sensor is pulsed at a frequency between _____ and _____ KHz.
- 2) Excess _____ is a measurement of the amount of light falling on the receiver in excess of the minimum light required to operate the sensor.
- 3) _____ is a scan technique in which the emitter and receiver are in one unit. Light from the emitter is transmitted in a straight line to a reflector and returned to the receiver.
- 4) Polarizing filters on a retroreflective scan sensor orientate planes of light _____ degrees to one another.
- 5) The correction factor for diffuse scan of cork with a photoelectric sensor is _____ %.
- 6) _____ operate is an operating mode in which the load is energized when light from the emitter of a photoelectric sensor is absent from the receiver.
- 7) Fiber optics is a scan technique.
 - a. true
 - b. false
- 8) Siemens laser photoelectric sensors use Class _____ lasers.

Photoelectric Family of Sensors

Siemens offers a wide variety of photoelectric sensors, including thru-beam, retroreflective scan, and diffuse scan sensors. There are many photoelectric sensors to choose from. Choice depends on many factors such as scan mode, operating voltage, environment, and output configurations. Most of these sensors can be used with some or all scan techniques. In addition, specialized sensors such as fiber optic, laser, and color sensors are available. To help simplify the process of determining the right sensor selection guides are provided. These guides do not list all the features of a given sensor. For a more detailed description refer to the appropriate catalog.

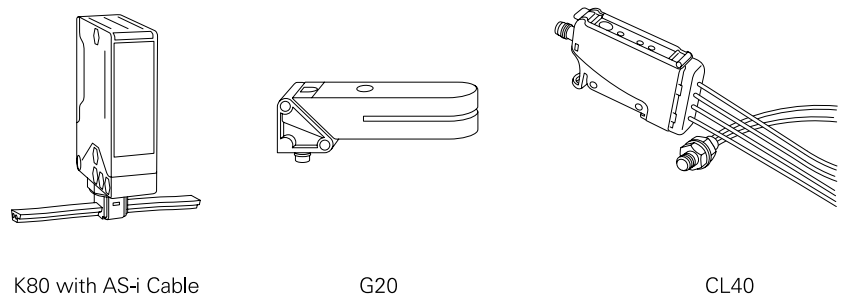
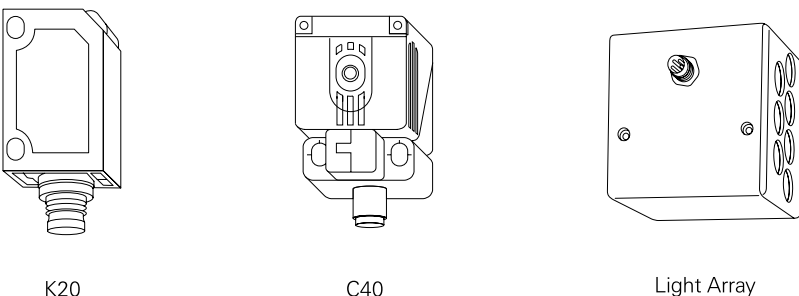
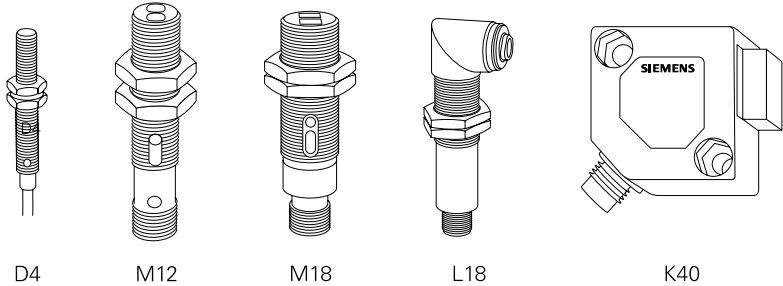

Thru-Beam Sensors

| Sensor | Range | Voltage | Output | | | Mode | | Connection | | | | | Housing | |
|----------------|--------|-------------------------|--------|-----|-------|------|----|------------|----|-----|-------|-----------|---------|---------|
| | | | PNP | NPN | Relay | DO | LO | AS-i | M8 | M12 | Cable | Terminals | | |
| D4/M5 | 250 mm | 10-30 VDC | X | X | | | X | | X | | X | | | Metal |
| M12 | 4 m | 10-30 VDC | X | X | | X | X | | | X | X | | | Metal |
| M18 | 6 m | 10-36 VDC | X | X | | X | X | | | X | X | | | Metal |
| M18M | 12 m | 10-30 VDC | X | X | | X | X | | | X | X | | | Metal |
| M18P | 12 m | 10-30 VDC | X | X | | X | X | | | X | X | | | Plastic |
| K30 | 12 m | 10-36 VDC | X | X | | X | X | | X | | X | | | Plastic |
| K35 | 5 m | 10-30 VDC | X | X | | X | X | | X | | X | | | Plastic |
| K40 | 15 m | 10-36 VDC | X | X | | X | X | | X | X | X | | | Plastic |
| K50 | 5 m | 10-30 VDC 15-264 VAC | X | X | X | X | X | X | | X | X | | | Plastic |
| K65 | 50 m | 10-30 VDC | X | X | | X | X | | | X | X | | | Plastic |
| K80 | 50 m | 10-36 VDC 20-320 VAC | X | X | X | X | X | X | | X | | X | | Plastic |
| L18 (Laser) | 50 m | 10-30 VDC | X | | | X | X | | | X | X | | | Metal |

Retroreflective Sensors

| Sensor | Range | Voltage | Output | | | Mode | | Connection | | | | | Housing | |
|----------------|-------|-------------------------|--------|-----|-------|------|----|------------|----|-----|-------|-----------|---------|---------|
| | | | PNP | NPN | Relay | DO | LO | AS-i | M8 | M12 | Cable | Terminals | | |
| M12 | 1.5 m | 10-30 VDC | X | X | | X | X | | | X | X | | | Metal |
| M18 | 2 m | 10-36 VDC | X | X | | X | X | | | X | X | | | Metal |
| M18M | 2 m | 10-30 VDC | X | X | | X | X | | | X | X | | | Metal |
| M18P | 2 m | 10-30 VDC | X | X | | X | X | | | X | X | | | Plastic |
| K20 | 2.5 m | 10-30 VDC | X | X | | X | X | | X | | X | | | Plastic |
| K30 | 4 m | 10-36 VDC | X | X | | X | X | | X | | X | | | Plastic |
| K35 | 2.5 m | 10-30 VDC | X | X | | X | X | | X | | X | | | Plastic |
| K40 | 6 m | 10-36 VDC | X | X | | X | X | | X | X | X | | | Plastic |
| K50 | 4 m | 10-30 VDC 15-264 VAC | X | X | X | X | X | X | | X | X | | | Plastic |
| K65 | 8 m | 10-30 VDC | X | X | | X | X | | | X | X | | | Plastic |
| K80 | 6 m | 10-36 VDC 20-320 VAC | X | X | X | X | X | X | | X | | X | | Plastic |
| L50 (Laser) | 12 m | 10-30 VDC | X | X | | X | X | | | X | X | | | Metal |
| Light Array | 1.4 m | 12-36 VDC | X | | | X | | | X | | | | | Plastic |
| C40 | 6 m | 10-36 VDC | X | X | | X | X | | | X | | | | Plastic |

Diffuse Sensors

| Sensor | Range | Voltage | Output | | | Mode | | Connection | | | | | Housing | |
|--------|--------|-------------------------|--------|-----|-------|------|----|------------|----|-----|-------|-----------|---------|---------|
| | | | PNP | NPN | Relay | DO | LO | AS-i | M8 | M12 | Cable | Terminals | | |
| D4/M5 | 50 mm | 10-30 VDC | X | X | | | X | | X | | X | | | Metal |
| M12 | 30 cm | 10-30 VDC | X | X | | X | X | | | X | X | | | Metal |
| M18 | 60 cm | 10-36 VDC | X | X | | X | X | | | X | X | | | Metal |
| M18M | 30 cm | 10-30 VDC | X | X | | X | X | | | X | X | | | Metal |
| M18P | 30 cm | 10-30 VDC | X | X | | X | X | | | X | X | | | Plastic |
| K20 | 30 cm | 10-30 VDC | X | X | | X | X | | X | | X | | | Plastic |
| K30 | 1.2 m | 10-36 VDC | X | X | | X | X | | X | | X | | | Plastic |
| K35 | 50 cm | 10-30 VDC | X | X | | X | X | | X | | X | | | Plastic |
| K40 | 2 m | 10-36 VDC | X | X | | X | X | | X | X | X | | | Plastic |
| K50 | 90 cm | 10-30 VDC 15-264 VAC | X | X | X | X | X | X | | X | X | | | Plastic |
| K65 | 2 m | 10-30 VDC | X | X | | X | X | | | X | X | | | Plastic |
| K80 | 2 m | 10-36 VDC 20-320 VAC | X | X | X | X | X | X | | X | | X | | Plastic |
| C40 | 2.5 cm | 10-30 VDC | X | X | | X | X | | | X | | | | Plastic |

Diffuse Sensors with Background Suppression

| Sensor | Range | Voltage | Output | | | Mode | | Connection | | | | | Housing | |
|----------------|--------|-------------------------|--------|-----|-------|------|----|------------|----|-----|-------|-----------|---------|---------|
| | | | PNP | NPN | Relay | DO | LO | AS-i | M8 | M12 | Cable | Terminals | | |
| M18 | 120 mm | 10-36 VDC | X | X | | X | X | | | X | X | | | Metal |
| M18P | 100 mm | 10-30 VDC | X | X | | X | X | | | X | X | | | Plastic |
| K20 | 100 mm | 10-30 VDC | X | X | | X | X | | X | | X | | | Plastic |
| K50 | 25 cm | 10-30 VDC 15-264 VAC | X | X | X | X | X | X | | X | X | | | Plastic |
| K65 | 50 cm | 10-30 VDC | X | X | | X | X | | | X | X | | | Plastic |
| K80 | 1 m | 10-36 VDC 20-320 VAC | X | X | X | X | X | X | | X | | X | | Plastic |
| L50 (Laser) | 150 mm | 10-30 VDC | X | X | | X | X | | | X | X | | | Metal |
| C40 | 2.5 cm | 10-30 VDC | X | X | | X | X | | | X | | | | Plastic |

Teach In

Some of the following sensors, such as the CL40, have a feature known as Teach In. This feature allows the user to teach the sensor what it should detect. An object to be detected is placed in front of the sensor so that it knows what the accepted reflected light is. The sensor is then programmed to respond only to this light. The CL40 uses a "SET" button to Teach In. Other sensors have different methods to Teach In. Teach In can be used to detect a specific color, for example. Teach In also works to detect transparent objects.

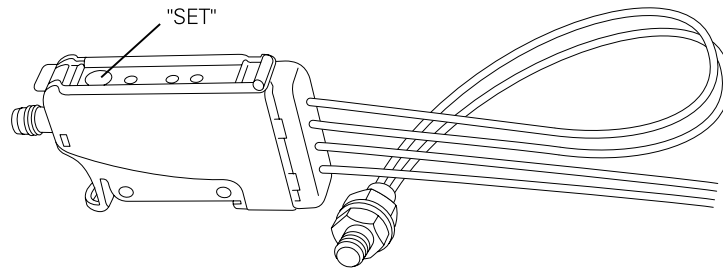

Fiber Optic Sensors

The basic operation is the same for optical fibers made of glass or plastics. Optical fibers are fitted in front of the transmitter and receiver and extend the "eye" of the sensor. Fiber optic cables are small and flexible and can be used for sensing in hard to access places.

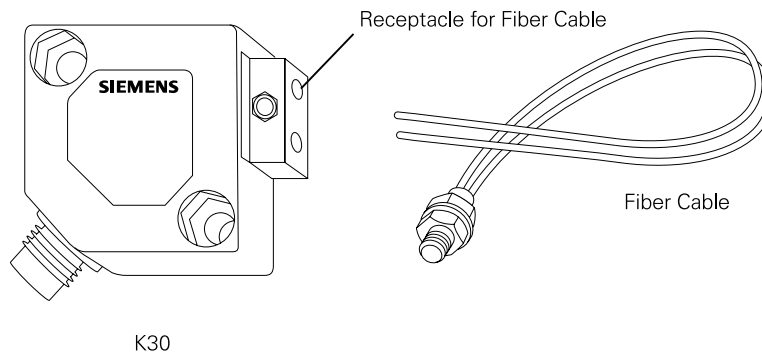

Laser Diffuse Sensor with Analog Output

The analog laser sensor is able to measure the exact distance of an object within its sensing range. This sensor uses a visible laser light with a highly accurate and linear output.

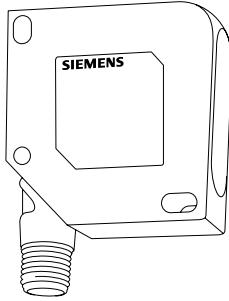

L50

Color BERO

The color BERO uses 3 LEDs with the colors red, green, and blue. Light is emitted to the target and can detect a specific color of reflected light. This sensor uses Teach In to set the color to be detected. The CL40 is also a fiber optic device.

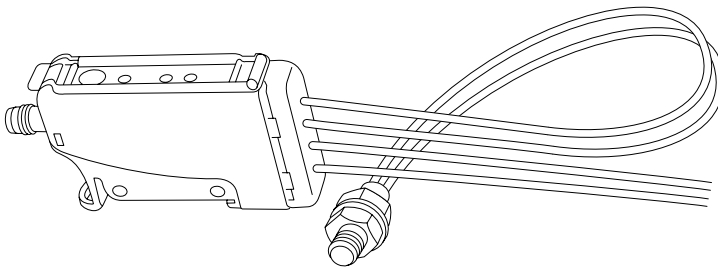

CL40

Color Mark BERO

The color mark BERO is also used to detect specific colors. This sensor works differently from the CL40. The color mark BERO uses green or red light for the emitter. The color is selected dependent on the contrast of the target. The target and background color can be set separately.

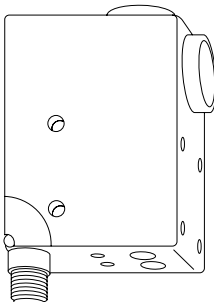

C80

Slot BERO

The target is placed inside the slot of the sensor. Emitted light passes through the object. Different contrast, tears, or holes in the target will vary the quantity of light reaching the receiver. This sensor uses Teach In. It is available with infrared or visible red/green light

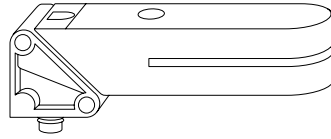

G20

Selection Guide

| Sensor Type | Sensor | Range | Voltage | Teach In | Output | | Mode | | Connection | | | Housing |
|-----------------------------|--------|----------|-----------|----------|--------|-----|------|----|------------|-----|-------|---------|
| | | | | | PNP | NPN | DO | LO | M8 | M12 | Cable | |
| Fiber Optic | K35 | 75 mm | 10-30 VDC | | X | X | X | X | X | | X | Plastic |
| | KL40 | 280 mm | 10-30 VDC | X | X | X | X | X | X | | X | Plastic |
| | K30 | 120 mm | 10-36 VDC | | X | X | X | X | X | | X | Plastic |
| | K40 | 150 cm | 10-36 VDC | | X | X | X | X | X | X | X | Plastic |
| Laser Diffuse Analog Output | L50 | 45-85 mm | 18-28 VDC | | | | | | | | X | Plastic |
| Color BERO | CL40 | 15 mm | 10-30 VDC | X | X | X | X | X | X | | X | Plastic |
| Color Mark BERO | C80 | 18 mm | 10-30 VDC | X | X | | X | X | | X | X | Metal |
| Slot BERO | G20 | 2 mm | 10-30 VDC | X | X | X | X | X | X | | | Metal |

Review 8

- 1) The maximum sensing range of a K80, thru scan, photoelectric sensor is _____ m.
- 2) _____ is an example of a photoelectric sensor with Teach In.
 - a. D4
 - b. K50
 - c. CL40
 - d. K30
- 3) A _____ is a photoelectric sensor that has a slot where the target is placed.
- 4) The maximum sensing range of a Color Mark BERO C80 is _____ mm.

Sensor Applications

There are any number of applications where sensors can be utilized, and as you have seen throughout this book there are a number of sensors to chose from. Choosing the right sensor can be confusing and takes careful thought and planning. Often, more than one sensor will do the job. As the application becomes more complex the more difficult it is to choose the right sensor for a given application. The following application guide will help you find the right sensor for the right application.



Ultrasonic Sensors

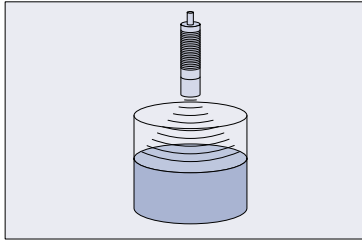

Application
Level Measurement in Large Vessels (Tanks, Silos)

Sensor
3RG61 13
Compact Range III

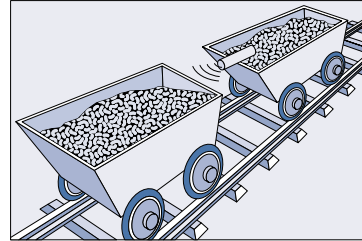

Application
Anti-Collision

Sensor
3RG60 14
Compact Range I

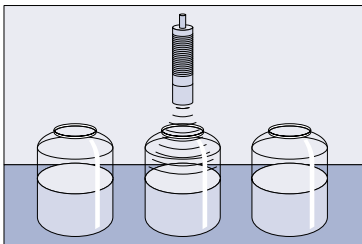

Application
Level Measurement in Small Bottles

Sensor
3RG61 12
Compact Range III

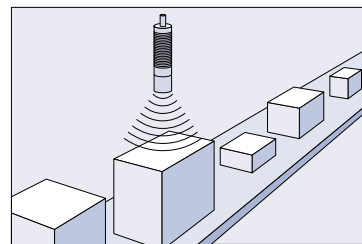

Application
Height Sensing

Sensor
3RG60 13
Compact Range II

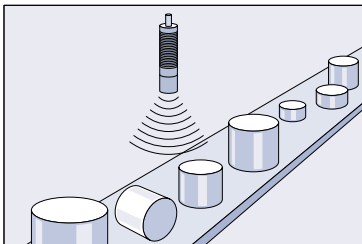

Application
Quality Control

Sensor
3RG61 12
Compact Range III

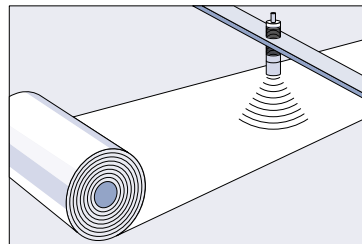

Application
Breakage Sensing

Sensor
3RG61 12
Compact Range I

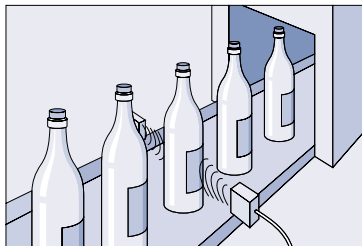

Application
Bottle Counting

Sensor
3RG62 43
Thru Beam

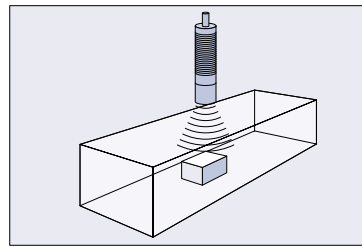

Application
Object Sensing

Sensor
3RG60 12
Compact Range II

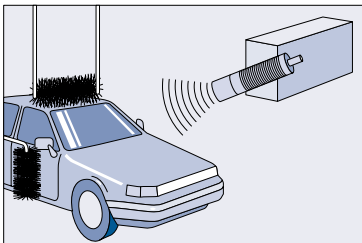

Application
Vehicle Sensing and Positioning

Sensor
3RG60 14
Compact Range III

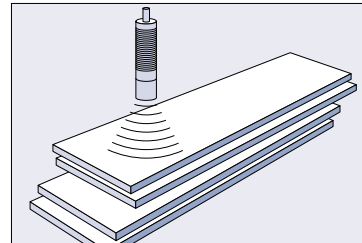

Application
Stack Height Sensing

Sensor
3RG60 13
Compact Range II

Ultrasonic Sensors

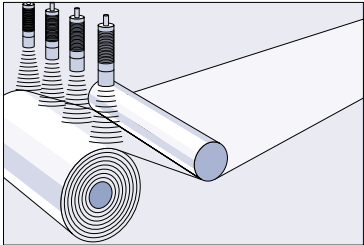

Application
Contour Recognition

Sensor
3RG61 13
Compact Range III

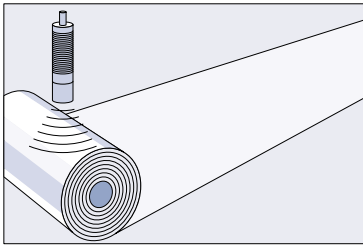

Application
Diameter Sensing and
Strip Speed Control

Sensor
3RG61 12
Compact Range III

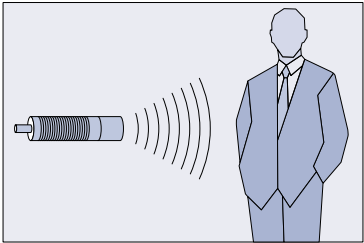

Application
People Sensing

Sensor
3RG60 12
Compact Range II

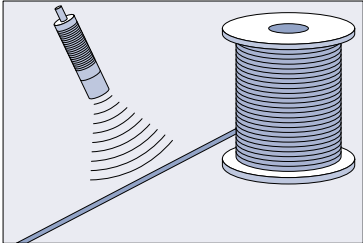

Application
Wire and Rope
Breakage Monitoring

Sensor
3RG60 12
Compact Range I

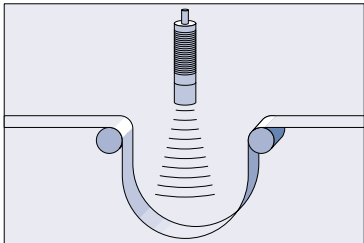

Application
Loop Control

Sensor
3RG60 15
Compact Range II

Photoelectric Sensors

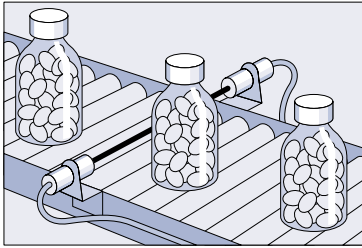

Application
Verifying Objects in
Clear Bottles

Sensor
M12 Thru Beam

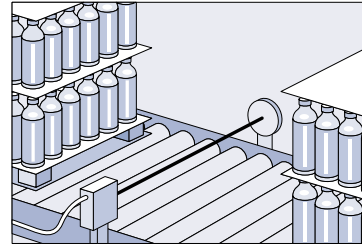

Application
Flow of Pallets
Carrying Bottles

Sensor
K40 Retroreflective

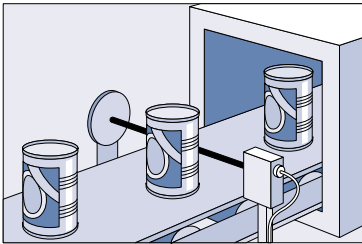

Application
Counting Cans

Sensor
K50 Polarized
Retroreflective

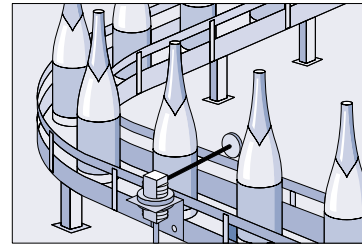

Application
Counting Bottles

Sensor
SL18 Retroreflective

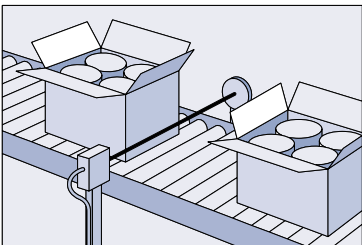

Application
Counting Cartons

Sensor
K65 Retroreflective

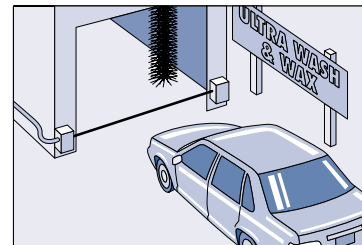

Application
Car Wash

Sensor
SL Thru Beam

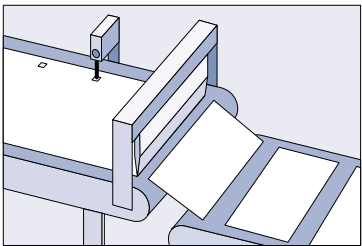

Application
Reading Reference
Marks for Trimming

Sensor
C80 Mark Sensor

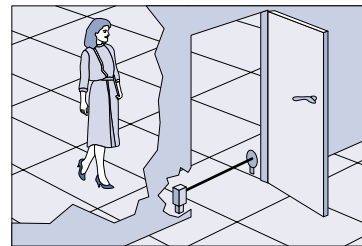

Application
Detecting Persons

Sensor
K50 Retroreflective

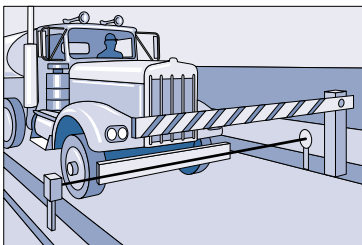

Application
Controlling Parking
Gate

Sensor
SL Retroreflective

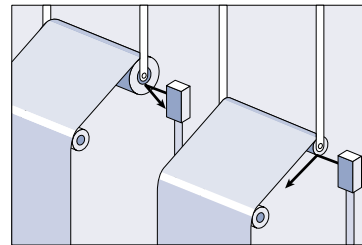

Application
End of Roll Detection

Sensor
K31 Diffuse

Photoelectric Sensors

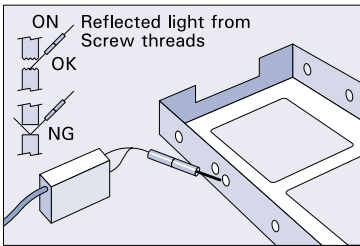

Application
Detecting Tab Threads

Sensor
KL40 Fiber Optic

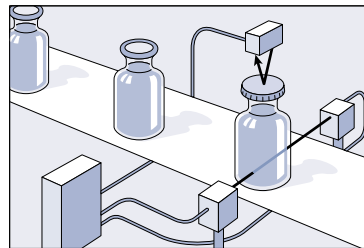

Application
Detecting Caps on Bottles

Sensor
K20 Diffuse with Background Suppression and K31 Thru Beam

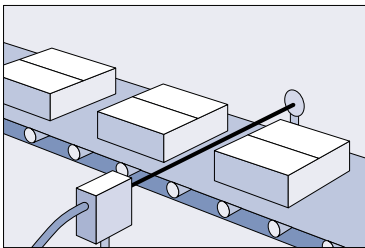

Application
Counting Packages

Sensor
K80 Retroreflective

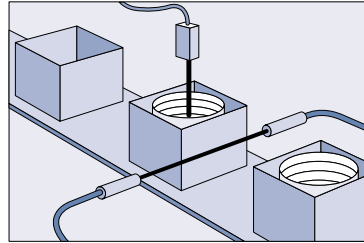

Application
Detecting Components Inside Metal Can

Sensor
K50 Background Suppression

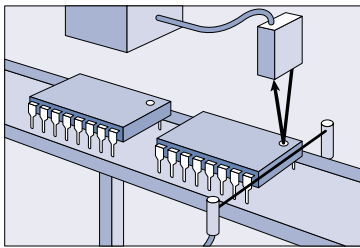

Application
Determining Orientation of IC Chip

Sensor
L50 Laser with Background Suppression

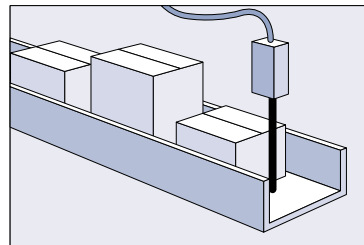

Application
Detecting Items of Varying Heights

Sensor
K80 Background Suppression

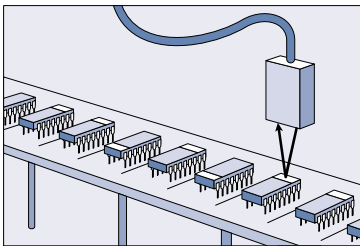

Application
Detecting Orientation of IC Chip

Sensor
Color Mark or Fiber Optic

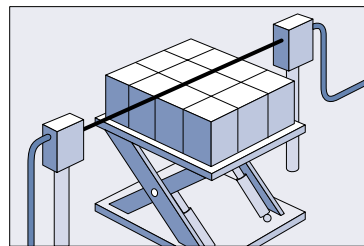

Application
Controlling Height of a Stack

Sensor
SL Thru Beam

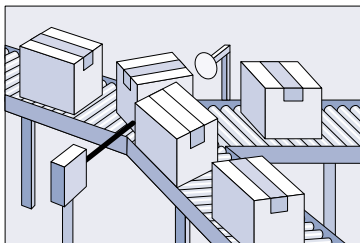

Application
Detecting Jams on a Conveyor

Sensor
K50 Retroreflective

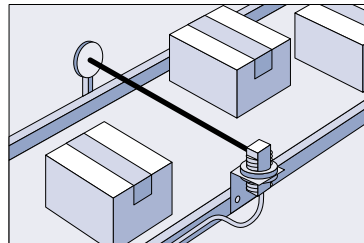

Application
Counting Boxes Anywhere on a Conveyor

Sensor
SL18 Right Angle Retroreflective

Photoelectric Sensors

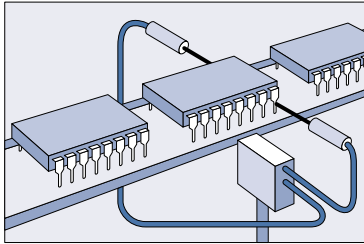

Application
Counting IC Chip Pins

Sensor
KL40 Fiber Optic

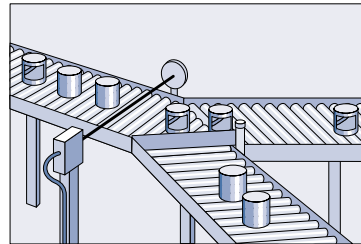

Application
Batch counting and
Diverting Cans
Without Labels

Sensor
K40 Polarized

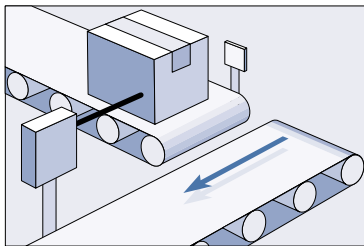

Application
Detecting Presence of
Object to Start a
Conveyor

Sensor
K35 Retroreflective

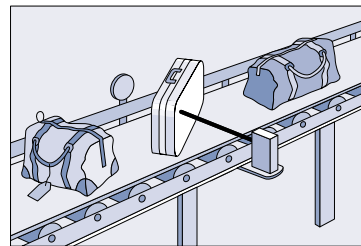

Application
Detecting Reflective
Objects

Sensor
K80 Polarized
Retroreflective

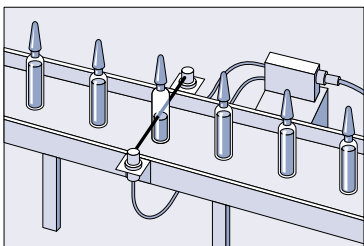

Application
Verifying Liquid in Vials

Sensor
K35 Fiber Optic

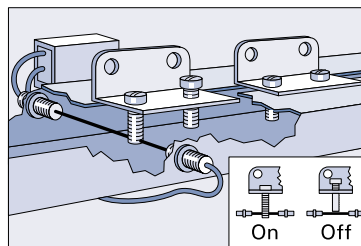

Application
Verifying Screws are
Correctly Seated

Sensor
KL40 Fiber Optic

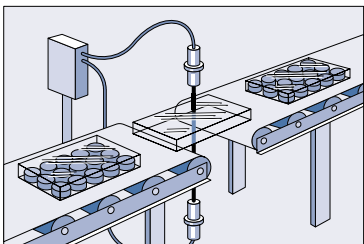

Application
Verifying Cakes are
Present in Transparent
Package

Sensor
KL40 Fiber Optic

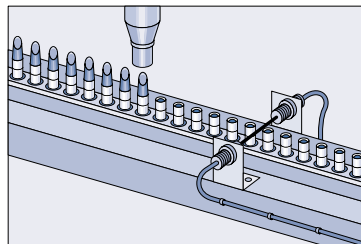

Application
Verifying Lipstick
Height Before Capping

Sensor
M5 or M12 Thru Beam

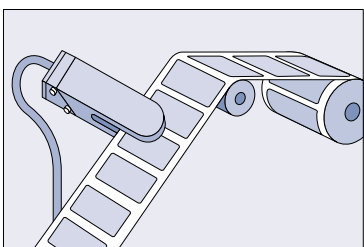

Application
Detecting Labels with
Transparent
Background

Sensor
G20 Slot Sensor

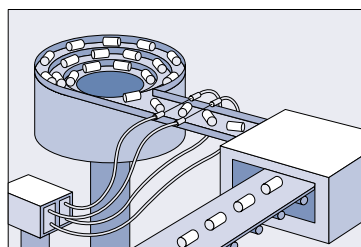

Application
Monitoring Objects as
they Exit Vibration
Bowl

Sensor
K35 Fiber Optic

Proximity Switches

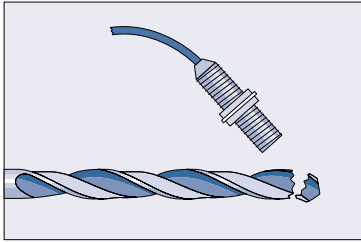

Application
Detecting the Presence of a Broken Drill Bit

Sensor
12 mm Normal Requirements

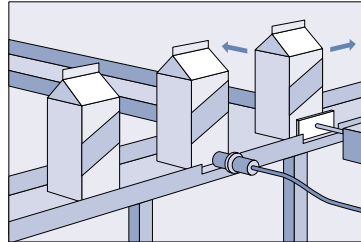

Application
Detecting Milk in Cartons

Sensor
Capacitive

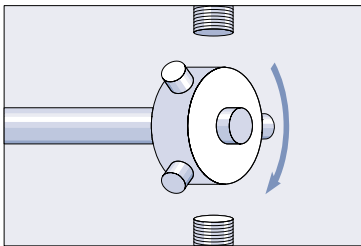

Application
Detecting Presence of Set Screws on Hub for Speed or Direction Control

Sensor
30mm Shorty

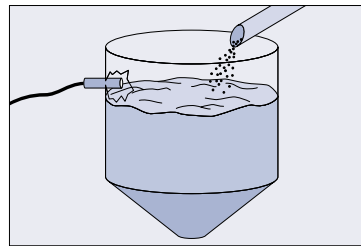

Application
Controlling Fill level of solids in a bin

Sensor
Capacitive

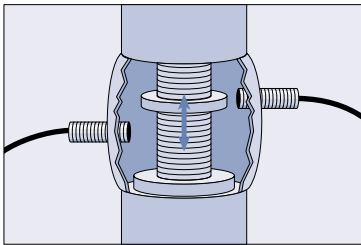

Application
Detecting Full Open or Closed Valve Position

Sensor
12mm or 18mm Extra Duty

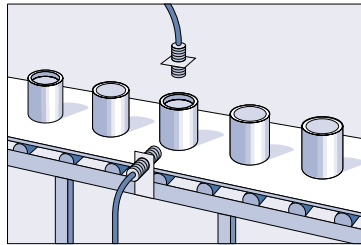

Application
Detecting Presence of Can and Lid

Sensor
30mm Normal Requirements or UBERO, 18mm Normal Requirements Gating Sensor

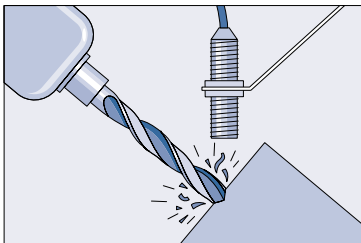

Application
Detecting Broken Bit on Milling Machine

Sensor
18 mm

Application Inquiry

Providing a sensing device solution requires both knowledge of the application and answers to specific questions to obtain key additional facts. This page is intended to be photocopied and used as a self-help guide in assessing the scope of sensor applications. The information recorded on this form may then be cross-checked with the product specifications found in our "BERO - Sensing Solutions" catalog to obtain a potential solution to your application. If your application involves machine guard safety interlocking, the use of standard position sensors could result in serious injury or death. Please contact SE&A Sensor Marketing for assistance at (630) 879-6000.

1. Target Material

- Metal Non-Metal
 Ferrous Non-Ferrous
 Transparent Translucent
 Opaque

2. Target Description and Dimensions

Target Finish
(shiny/dull/matte, etc.) _____
Target Color _____
Target Texture _____

3. Target Orientation/Spacing

Describe position of target when sensed relative to immediate environment.

Number of Multiple Targets _____
Number of Targets Nested Together _____
Spacing Between Targets _____
Size of Target _____

4. Target Movement/Speed/Velocity

Describe how the target approaches the sensing area (Axial/Lateral).

Target Speed _____
Cycles per Second/Minute/etc _____
Hours machine is run? _____

5. Sensing Distance

From Target to Sensor _____
From Target to Background _____

6. Background Description

Describe the background conditions.

7. Physical/Mounting Criteria

Is target accessible from more than one side?

Space available to install sensor _____

Sensor Orientation Possibilities _____

8. Environment

Clean Oily Dusty
 Humid Outdoor Indoor
 Submersion Wash down
Temperature _____
Temperature Variation _____

9. Load Requirements

Describe the Load _____
Inductive: Inrush _____ Sealed _____

10. Control Voltage Supply

_____ VAC _____ VDC

11. Output Requirements

NPN PNP SCR FET
 Relay
 Normally Open Normally Closed
 Complimentary LO/DO

12. Connection Preference

Connector/Matching Cordset
Length of Sensor Prewired Cable
(2 Meters Standard) _____
 AS-i Interface

Review Answers

- Review 1** 1) Limit switch; 2) d; 3) Pretravel; 4) operating position; 5) break-before-make; 6) Break; 7) 30; 8) operating head; 9) SIGUARD; 10) 6P
- Review 2** 1) inductive; 2) a; 3) 3; 4) 4; 5) steel; 6) 0.40; 7) 81%
- Review 3** 1) 10; 2) 20; 3) 265, 320; 4) IP; 5) 65; 6) UBERO
- Review 4** 1) electrostatic; 2) any; 3) dielectric; 4) b; 5) 20
- Review 5** 1) sound; 2) 6-80; 3) 5; 4) 60; 5) 3; 6) Diffuse
- Review 6** 1) Thru-Beam; 2) 5 to 40; 3) separate; 4) a; 5) SONPROG; 6) Modular; 7) b
- Review 7** 1) 5 and 30; 2) gain; 3) Retroreflective; 4) 90 degrees; 5) 65; 6) Dark; 7) b; 8) 2
- Review 8** 1) 50; 2) c; 3) G20; 4) 18

Final Exam

The final exam is intended to be a learning tool. The book may be used during the exam. A tear-out answer card is provided. After completing the final exam, mail in the answer card for grading. A grade of 70% or better is passing. Upon successful completion of the test a certificate will be issued.

Questions

1. The distance an actuator arm travels on a mechanical limit switch from the release position to the free position is known as _____ .
 - a. Overtravel
 - b. Differential Travel
 - c. Pretravel
 - d. Release Travel
2. _____ is a term that describes the load a mechanical limit switch can handle when the mechanical contacts close.
 - a. Make
 - b. Break
 - c. Continuous
 - d. Inductive
3. _____ are the two product lines for Siemens mechanical limit switches.
 - a. International and IEC
 - b. International and North American
 - c. North American and BERO
 - d. International and BERO
4. _____ is a type of sensor that can only detect metal.
 - a. Photoelectric
 - b. Ultrasonic
 - c. Inductive
 - d. Capacitive
5. When two or more shielded inductive proximity sensors are mounted opposite one another, they should be placed a distance of at least _____ times the rated sensing range from each other.
 - a. two
 - b. three
 - c. four
 - d. six

12. Coarse-grained materials can have as much as _____ degrees angular deviation from the send direction of an ultrasonic sensor.
- a. 3
 - b. 5
 - c. 45
 - d. 90
13. Sound velocity decreases _____ % between sea level and 3000 m above sea level.
- a. 0.17
 - b. 3.6
 - c. 5
 - d. 25 - 33
14. A signal evaluator is required for use with _____ ultrasonic sensors.
- a. Compact Range 0
 - b. Compact Range I
 - c. Compact Range III
 - d. Modular Range II
15. The maximum sensing distance of a Thru Beam ultrasonic sensor is 80 cm when _____ .
- a. X1 is open
 - b. X1 is connected to L+
 - c. X1 is connected to L-
 - d. X1 is closed
16. SONPROG can be used to adjust _____ ultrasonic sensors.
- a. Thru Beam
 - b. Compact Range 0 and Compact Range I
 - c. Compact Range I and Compact Range II
 - d. Compact Range II and Compact Range III
17. A 90° diverting reflector is available for use with _____ ultrasonic sensors.
- a. M30 spherical
 - b. Compact Range M18 spherical
 - c. Compact Range 0 with Integrated Transducer
 - d. Thru Beam

18. _____ scan is a photoelectric scan technique in which the planes of emitter light and reflected light are orientated 90° to one another.
- a. Polarized Retroreflective
 - b. Retroreflective
 - c. Diffuse
 - d. Thru
19. _____ is a photoelectric sensor that use three LEDs with colors red, green, and blue and is can be used to detect a specific color of reflected light.
- a. G20
 - b. K30
 - c. CL40
 - d. C80
20. The maximum sensing range of the L18 laser photoelectric sensor is _____ .
- a. 12 m
 - b. 50 m
 - c. 100 mm
 - d. 150 mm

Notes